

FableKids

love inspired.



Child Car Seat

MIKA



ECE R129/03
V.072023

Thank you for choosing Fable Kids.

Please read the instructions carefully before use and keep for future reference.

Table of Contents

1. Product Overview	1
2. Important Safety Information	4
3. Come utilizzare il prodotto	6
4. Installation	14
5. Care instruction	20
6. Environmentally Friendly Disposal	21



FableKids

love inspired.

Dear Parents,
Thank you for purchasing our product. Please read the operating instructions carefully before using the product for the first time. If you give the product to a third party, this manual must be handed over with it. Keep the instruction manual for future reference. The drawings in this manual may not match the physical objects. Please refer to the physical objects.

1. Product Overview

1.1 Part names

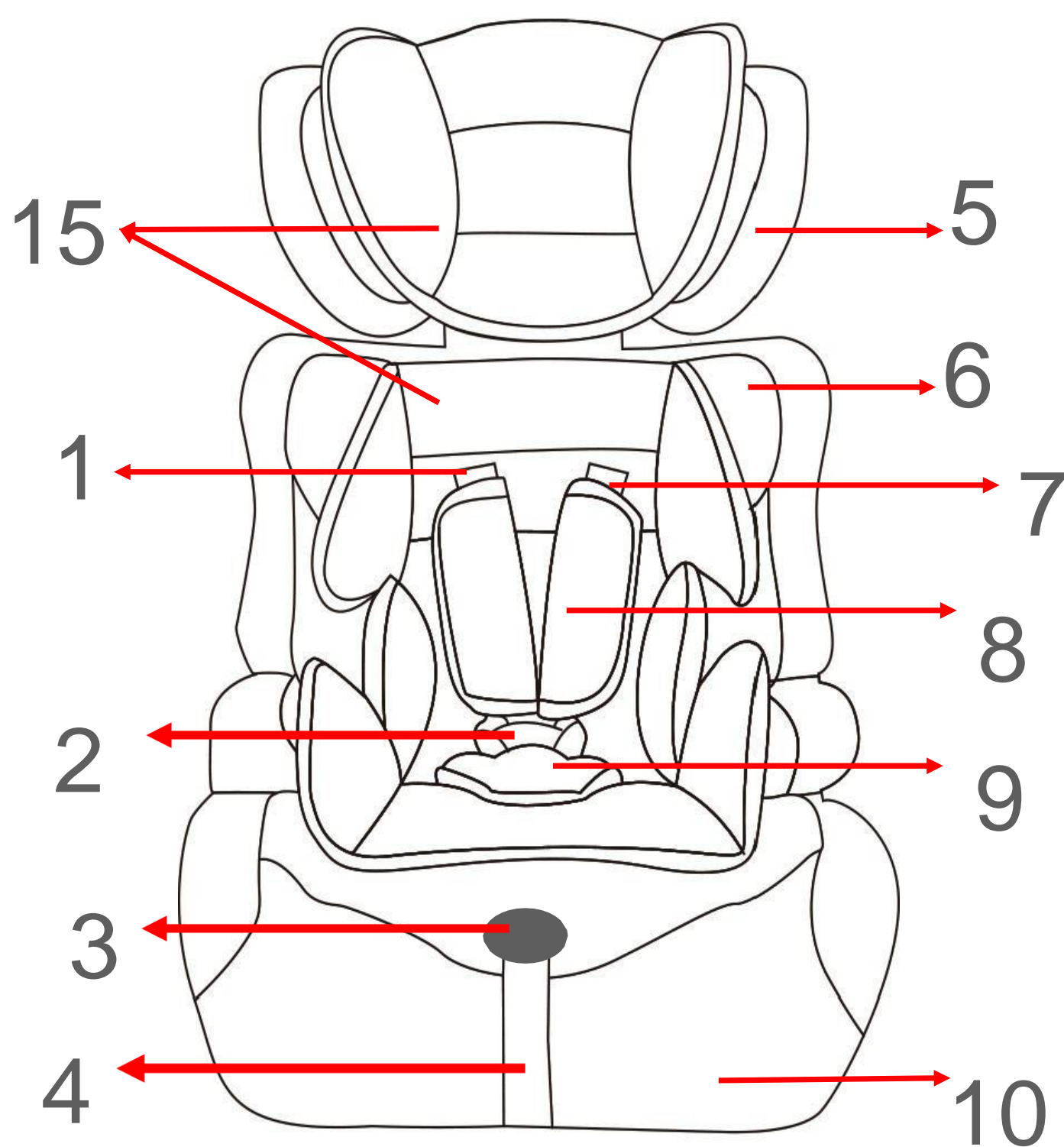

1. Belt Slot
2. Buckle
3. Hardness adjuster lever
4. Hardness adjuster strap
5. Headrest
6. Backrest
7. Harness
8. Shoulder pad
9. Buckle pad
10. Booster cushion

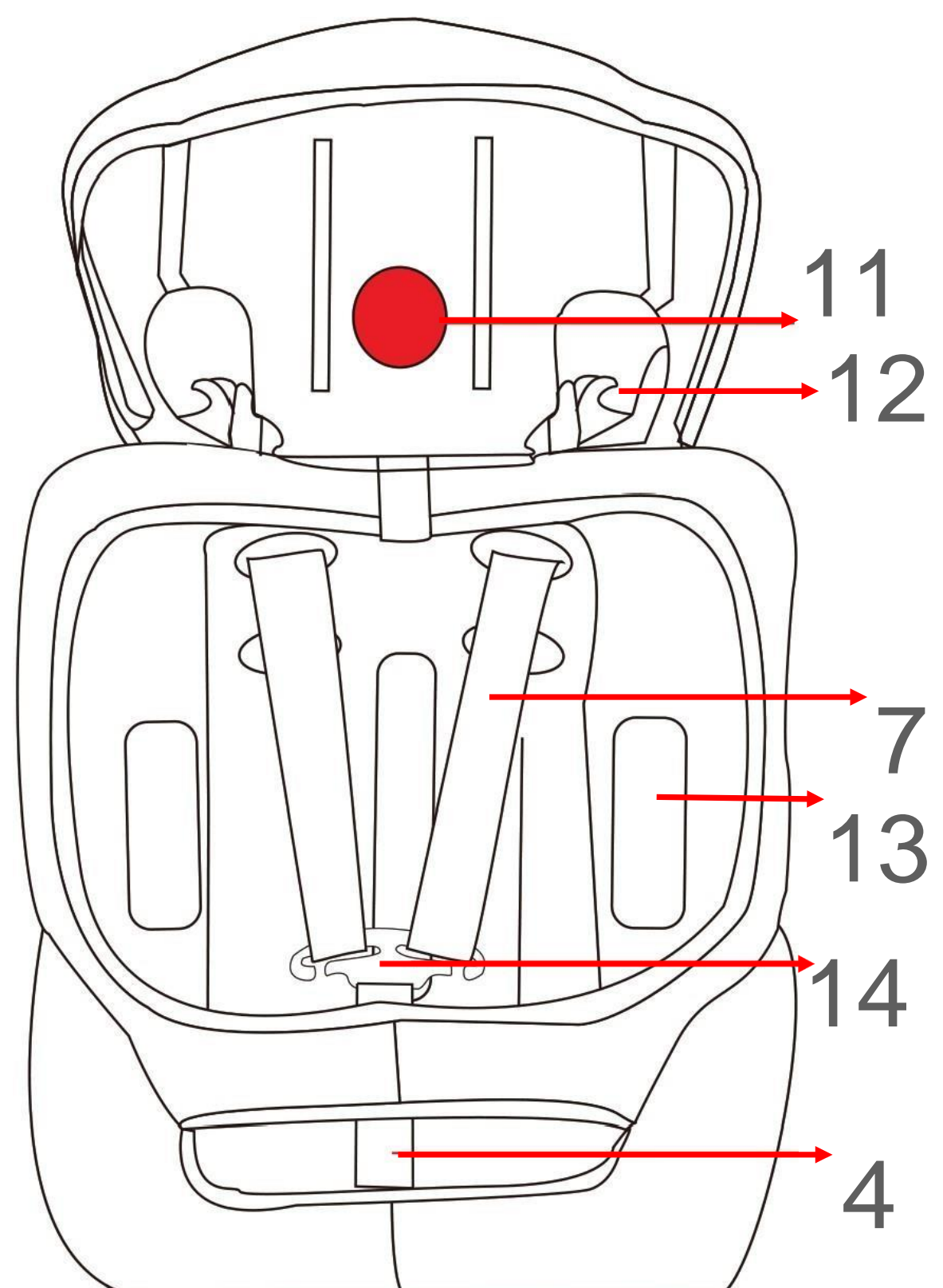

11. Height adjuster
12. Head belt guide
13. Adult belt route slots
14. Hardness connector
15. Baby insert

1. Product Overview

1.2 Suitable Size Range

The MIKA car seat is designed for children from 76 cm to 150 cm in height and can be installed facing forward.

You can use your child car seat as follows:

Size Range	Installation		Category	Class	Child restraint mode
76-105cm	Forward facing	Adult three point safety belt	Universal Belted	Integral	Harness belt
100-125cm	Forward facing	Adult three point safety belt	i-size booster seat	Non-integral	Adult three-point safety belt
125-150cm	Forward facing	Adult three point safety belt	Universal booster cushion	Non-integral	Adult three-point safety belt

- **"Universal Belted"** using the seat with backrest, which is fixed with three-point seat belts of a car. And then children are fixed on the seat by the seat belts.
- **"i-size booster seat"** using the seat with backrest which removes its own belts. The car seat and the child are all fixed with three-point seat belts of the car.
- **"Universal booster cushion"** use the seat without backrest which removes its own belts. The car seat and the child are all fixed with three-point seat belts of the car.

This kind of restraint device can be used on condition that it has passed the EU R16 regulations or other equivalent standards certification which can prove that the motor vehicle is equipped with three-point static belt adjuster which meets the requirements.



1. Product Overview

The car seat can be installed in the car in the places indicated by the manufacturer in the vehicle manual. It is required to read the vehicle manufacturer's operating instructions.

NOTICE FOR CHILD SIZE RANGE 76-105CM:

- This is Universal Belted Enhanced Child Restraint System. It is approved according to UN Regulation No. 129, for use primarily in "Universal seating positions" as indicated by vehicle manufacturers in the vehicle user's manual.
- **IMPORTANT – DO NOT USE BEFORE THE CHILD'S AGE EXCEEDS 15 MONTHS (Refer to instruction).**
- If in doubt, consult either the Enhanced Child Restraint System manufacturer or the retailer.

NOTICE FOR CHILD SIZE RANGE 100-125CM:

- This is an i-Size booster seat Enhanced Child Restraint System. It is approved according to UN Regulation No. 129, for use primarily in all " i-Size seating positions" as indicated by vehicle manufacturers in the vehicle user's manual.
- If in doubt, consult either the Enhanced Child Restraint System manufacturer or the retailer.

NOTICE FOR CHILD SIZE RANGE 125-150CM:

- This is a Universal booster cushion Enhanced Child Restraint System. It is approved according to UN Regulation No.129, for use in i-Size compatible and universal vehicle seating positions as indicated by vehicle manufacturer in the vehicle user's manual.
- If in doubt, consult either the Enhanced Child Restraint System manufacturer or the retailer.

2. Important Safety Information

WARNING

- Before use the product, please read the instruction manual carefully. The product is a safety product and is only safe when used in accordance with the instruction manual.
- For the future use of the seat, you must keep the instruction manual.
- Never leave your child unattended in the car.
- The car seat is designed to be mounted only on forward-facing seats.
- Do not use a child safety seat if the vehicle seat is equipped with front airbags. This can be dangerous. This does not apply to so-called side airbags.
- The product must be used on a forward facing seat that is fitted with 3-point belt which is approved according to ECE R16 or an equivalent standard.
- The product may be used on either the front or the back seat. However, we recommend that it is fitted on the back seat.
- The product has been approved according to the strictest European safety standards (ECE R129/03) and is suitable for children with a height from 76-150cm.
- "IMPORTANT - DO NOT USE FORWARD FACING BEFORE THE CHILD'S AGE EXCEEDS 15 months (Refer to instructions)".
- Remember that the internal safety harness holding the child should be adapted to the child's body shape and not twisted. For this reason, child should not wear thick clothes under the safety harness.
- After an accident the seat may become unsafe due to damage that is not be noticeable immediately. It should therefore be replaced.
- The safety of the seat can only be guaranteed by the manufacturer if it issued by the original owner.
- We advise you strongly that not to use a second-hand product, because you are not sure what has happened to it.
- The harness pads are important for the safety of your child, therefore use them at all the time.
- Ensure that all luggage and objects likely to cause injury in the event of an accident are properly secured.

2. Important Safety Information



WARNING

- It is recommended that the car seat should not be used more than 5 years from the date of production. The properties of the products may deteriorate due to, for example, ageing of the plastic and this may not be visible.
- The moving parts of the car seat should not be lubricated in any way.
- The baby car seat must not be used without the cover. Please use an original cover, as the cover contributes to the safety of the seat.
- The seat must be secured with a seat belt, even when it not on use. An unsecured seat may injure other passengers in the car in an urgent stop.
- The rigid items and plastic parts of a child restraint must be so located and installed that they are not liable, during everyday use of the vehicle, to become trapped by a movable seat or in a door of the vehicle.
- Ensure that the seat is not damaged by the webbing between or underneath heavy luggage, adjustable seats or slamming the car door etc.
- No alterations may be made to the product as this could affect part or the overall safety of the seat.
- In hot weather the plastic and metal parts of the product will be hot. You should cover the seat when the car parked under the sun.
- In order to prevent damage to the cover, do not remove the product's logo.
- Use the seat even in a short journey, as this is when most accidents occur.
- Take a short break in long journey. So that your child has some time for the relaxation.
- Set a good example yourself and always wear your seat belt.
- Tell your child that he/she should be never play with the harness buckle.
- **REMARK:** Your car seat can be fixed safely on almost seats of the cars. However, on some seats the belts are fixed so that proper installation is not possible, in that case, try another seat.

3. How to Use the Product

3.1 Use in the vehicle

You can use your child car seat as follows:

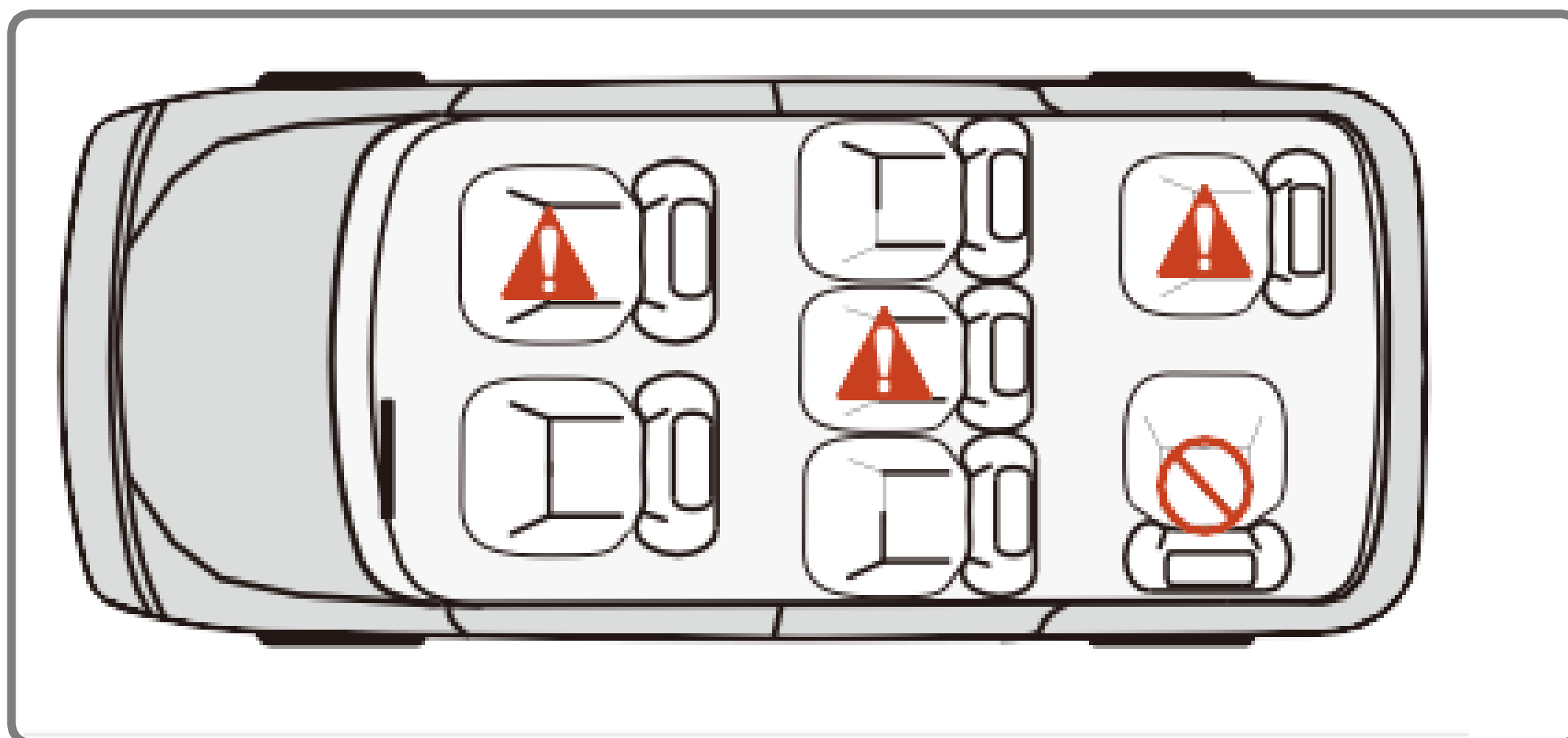

- The car seat is designed to be mounted only on forward-facing seats.
- **ATTENTION! THE CAR SEAT MUST NOT BE MOUNTED ON REARWARD FACING OR SIDE FACING SEATS.**

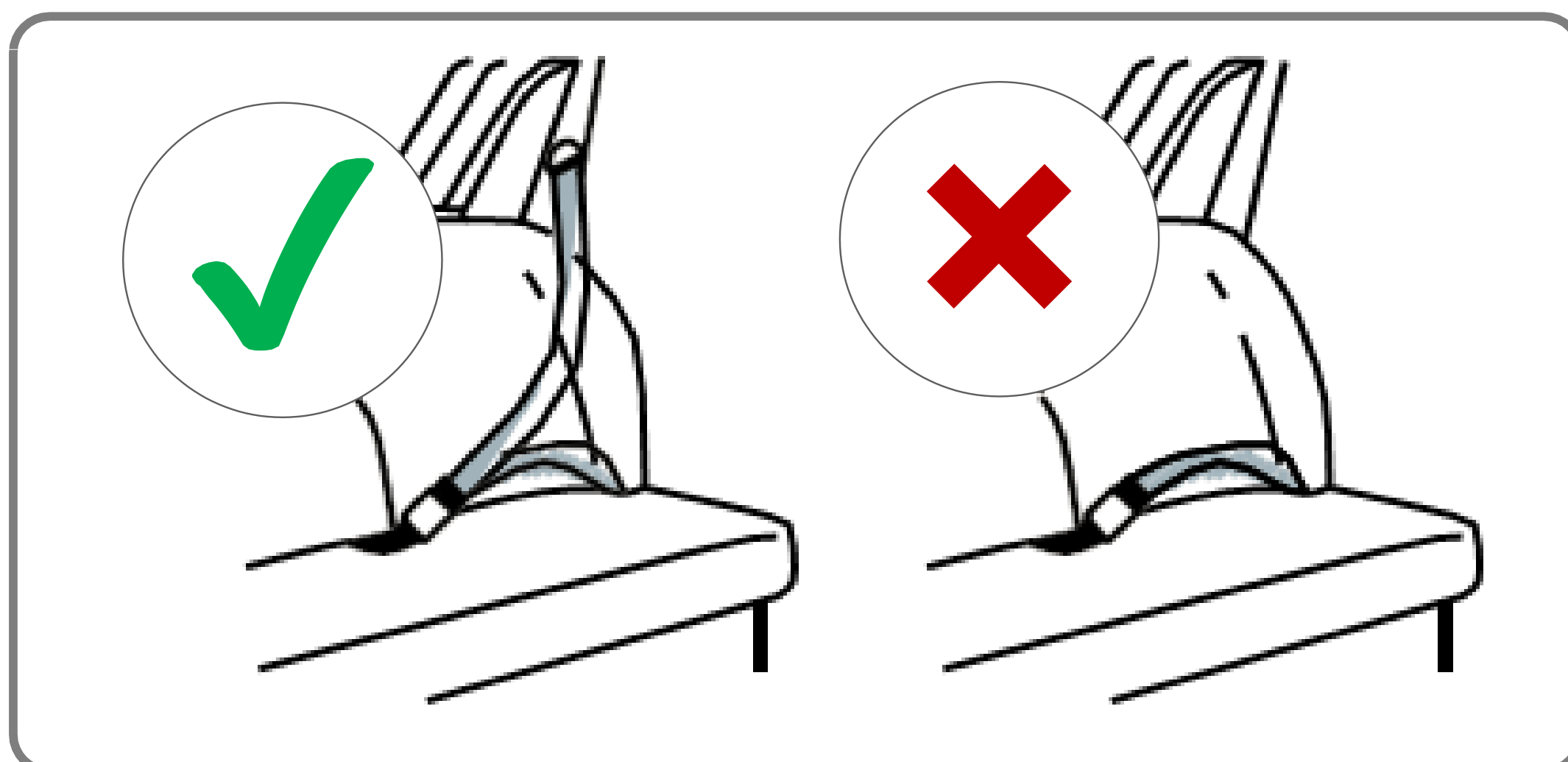

Please observe the regulations applicable to your particular country. The safety belt must be approved to ECE R 16 or other equivalent standards.

DO NOT USE WITH 2-POINT BELT.
Please install with the 3-point belt.

3. How to Use the Product

3.1 Use in the vehicle

▪ In the direction of travel	Correct
▪ Against the direction of travel	Error
▪ Vehicle is fitted only with 2-point safety belt.	Error
The use of a 2-point belt substantially increases the risk of injury to your child in the event of an accident.	
▪ Vehicle is fitted with 3-point safety belt.	Correct
The safety belt must be approved to ECE R16 or a comparable standard (see test label on belt with an "E" or "e" in a circle).	
▪ On front passenger seat	Correct (1)
*** (1) Do not use on passenger seats with a front airbag!	
▪ On outer rear seat	Correct
▪ On centre rear seat*	Correct (2)
*** (2) Can be used if the vehicle seat is equipped with 3-point belt	

(Please observe the regulations applicable to your particular country).



IMPORTANT!

- If the car seat is installed in the front seat, the front air-bag must be deactivated. It is recommended to install the car seat only on the back seats of the car.
- Please refer to your vehicle operating manual for information on the suitability of the seat for use with a car seat.

3. How to Use the Product

3.2 Securing your baby using the baby insert

The baby insert improves comfort and gives extra support for children. We recommend using the lower part as well as the upper part, which serves as a pillow for the child's head until the child needs more space in the car seat. Then the inserts should be removed.

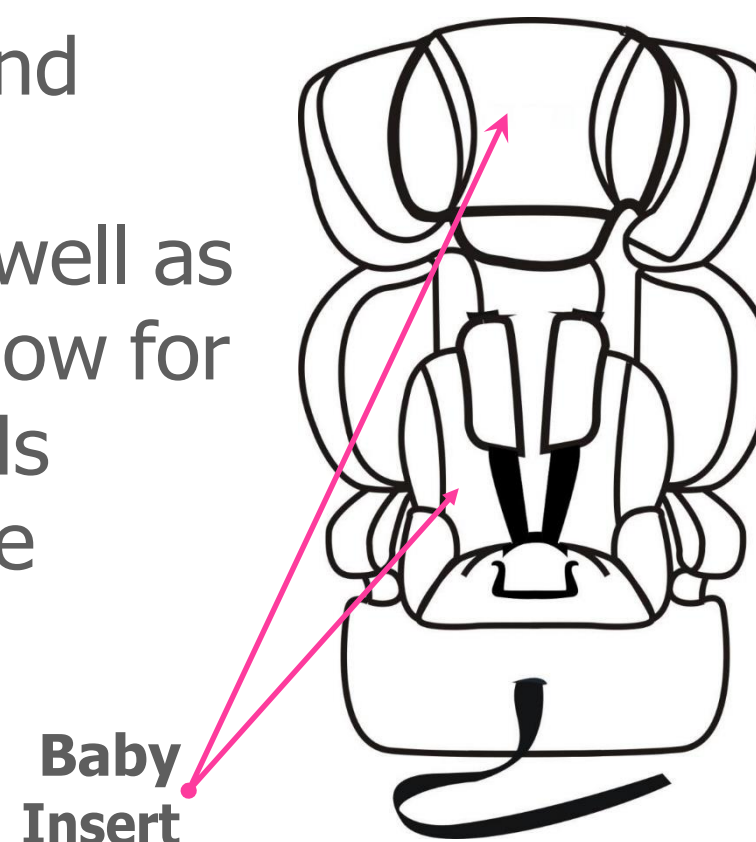

- **Installation of insert**
- Unfasten the internal safety harness (7) by pressing the red button on the buckle (2).
- Place the insert in the car seat so that it adheres to the sides.
- Adjust the position of the internal safety harness. Check whether the safety harness is not twisted.
- Using a strap, place the upper part of the insert on the headrest.



For the protection of your baby

- **IMPORTANT TO KNOW:**
- Always secure your baby in the car seat using the harness.
- Never leave your baby unattended in the car seat when placing it on elevated surfaces (e.g. a table, nappy changing unit, etc.).
- Never allow the strap end to become caught in moving parts (e.g. automatic doors, escalators, etc.).
- **Caution! The plastic parts of the car seat heat up in the sun, so that your baby may get burnt. Protect your baby and the car seat against intensive solar radiation (e.g. by putting a light cloth over the seat).**
- Take your baby out of the car seat as often as possible to relieve its spine.
- We recommend frequent breaks during long journeys. Even outside of the car, please avoid leaving your baby in the car seat for too long.

3. How to Use the Product

3.3 How to adjust the belts and headrest

- **Adjusting the belts**

Loosen the harness straps by pressing the release button and pulling the harness straps towards yourself.

Note! Do not pull the shoulder pads.

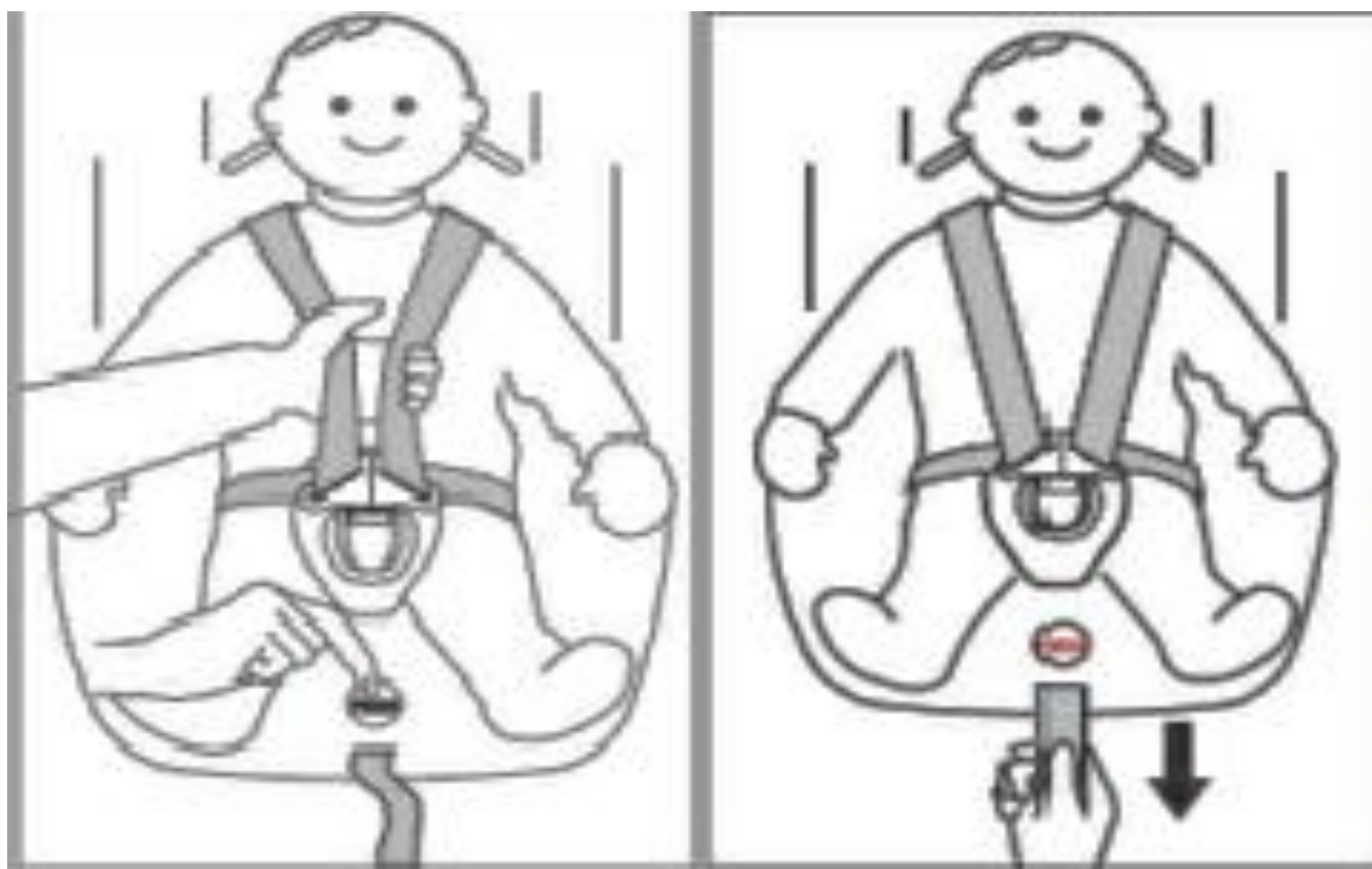

CORRECT SHOULDER STRAP HEIGHT



IMPORTANT! The correct belt height of the shoulder belts is attained when the belt disappears into the shell slightly above the shoulder of the child.

Make sure that the shoulder belts fit properly over the shoulders of the child.

3. How to Use the Product

3.3 How to adjust the belts and headrest

- **Adjusting the shoulder strap height**

If the height of your car seat does not fit your child, you need to adjust it according to the following steps (Fig.1-5):

- Step 1: Loosen the belt and then turn the child seat to the rear (Fig. 1).
- Step 2: Slide two shoulder straps from the connector (Fig. 2).
- Step 3: Draw shoulder pad and straps out of the belt slot (Fig. 3).
- Step 4: Wear the shoulder straps through the desired corresponding belt slots (Fig.4)
- Step 5: Make sure that the seat belts are properly installed in the slots, and there is no distortion. Attach the straps back on the harness connector (Fig.5).
- To remove the straps do the above in reverse order.

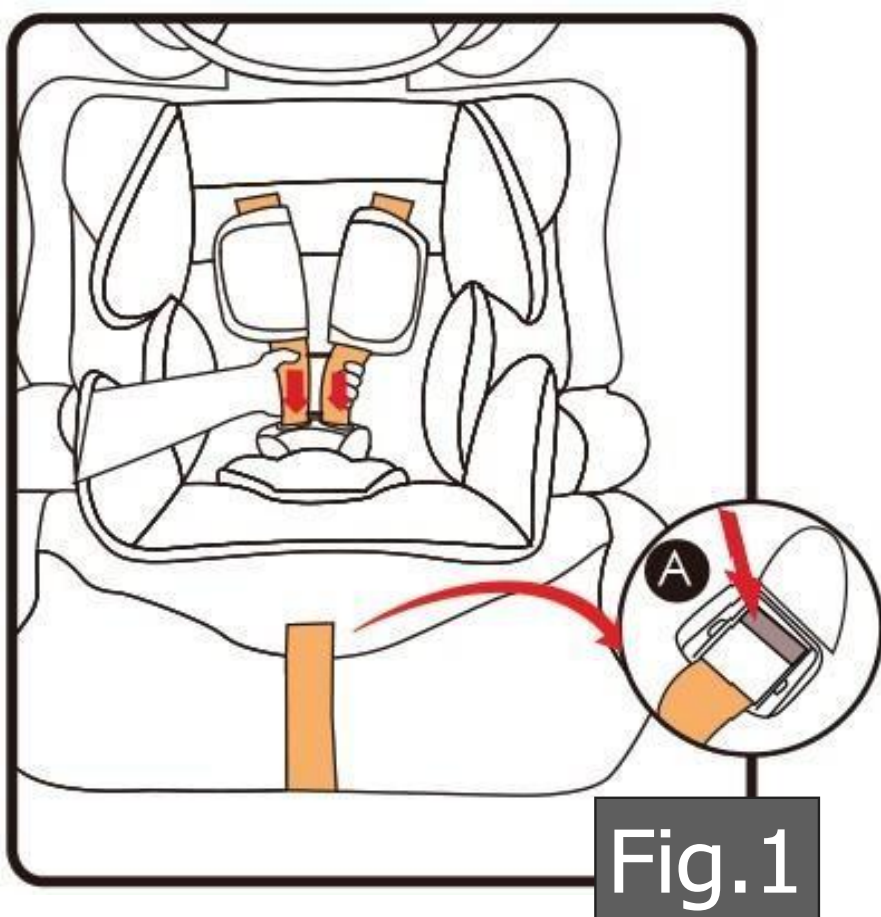

Fig.1

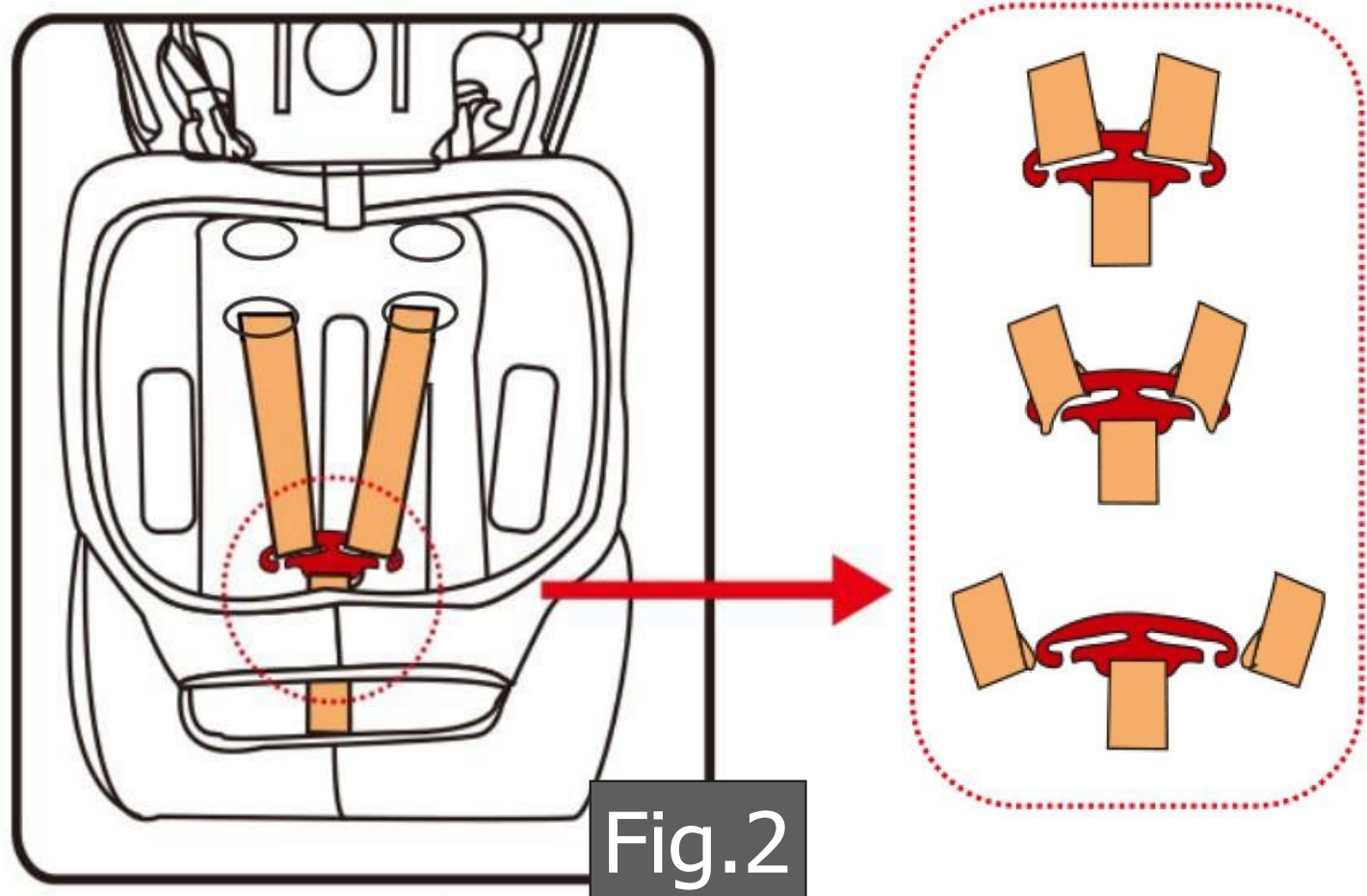

Fig.2

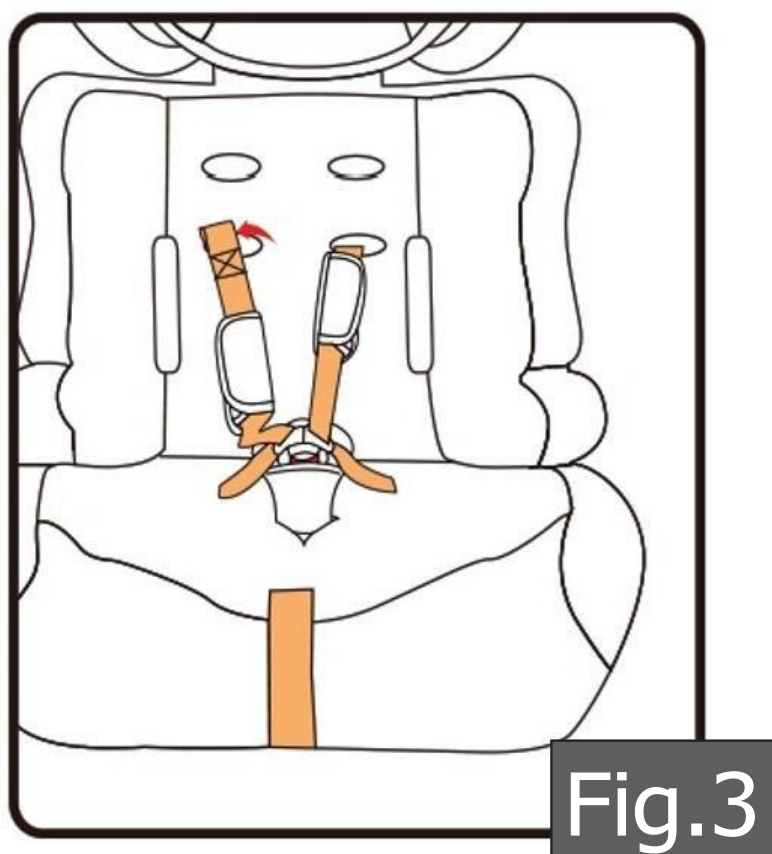

Fig.3

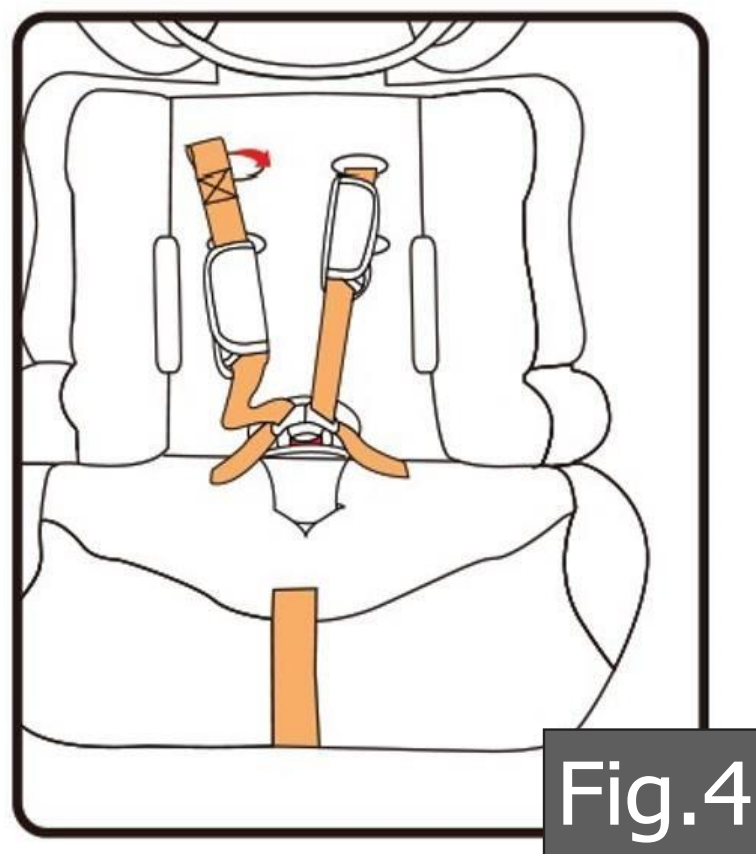

Fig.4

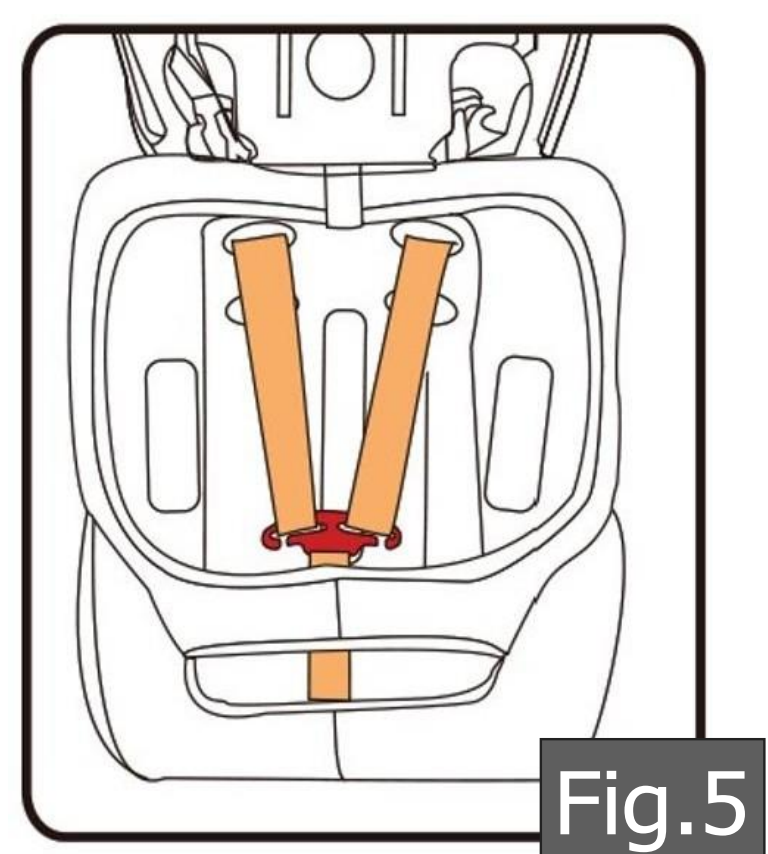
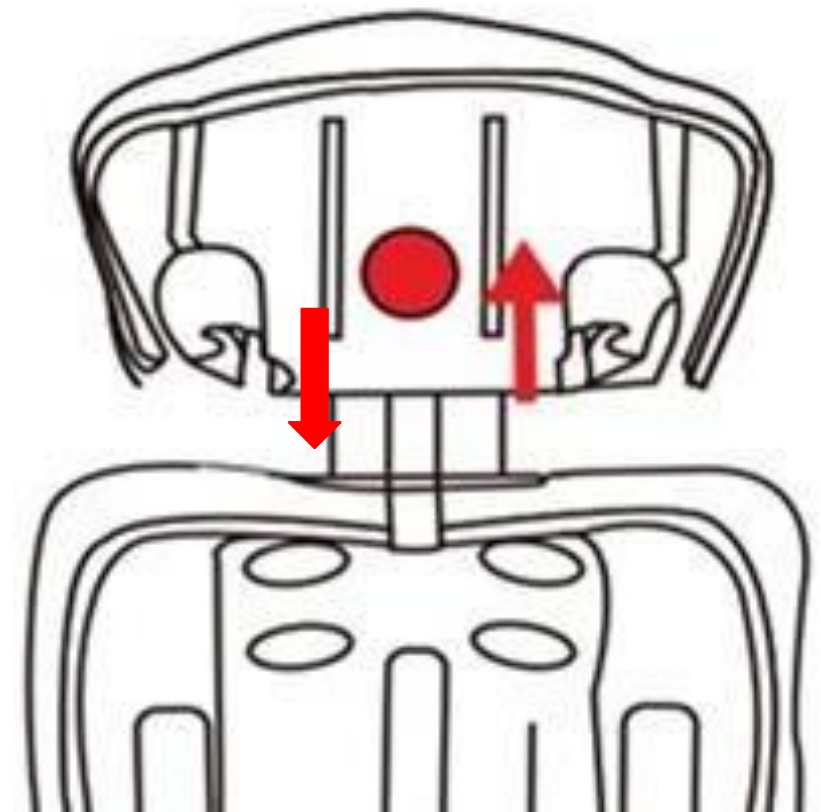

Fig.5

3. How to Use the Product

3.3 How to adjust the belts and headrest

- **Adjusting heights of the head rest**
- The headrest can be set different heights. Press the red button on the top of the backside of the seat and pull the headrest gently upwards to unlock. The headrest can now be adjusted to the desired height (up/down).
- Let go of the button and the headrest will be locked .



IMPORTANT! Make sure the seat headrest is locked in place, try to move it up and down. Make sure the head rest fit properly to head.

ATTENTION! Proper adjustment of the headrest height has a direct impact on the child's safety. Place the car seat on the vehicle seat. Place your child in the car seat and check the height of the headrest. Attention! If necessary, repeat the steps to adjust the headrest height until you reach the optimal height.

3. How to Use the Product

3.4 Securing your baby using the harness

- Loosen the harness straps by pressing the release button A and pulling the harness straps as far as you can.
- **Note! Do not pull the shoulder pads.**

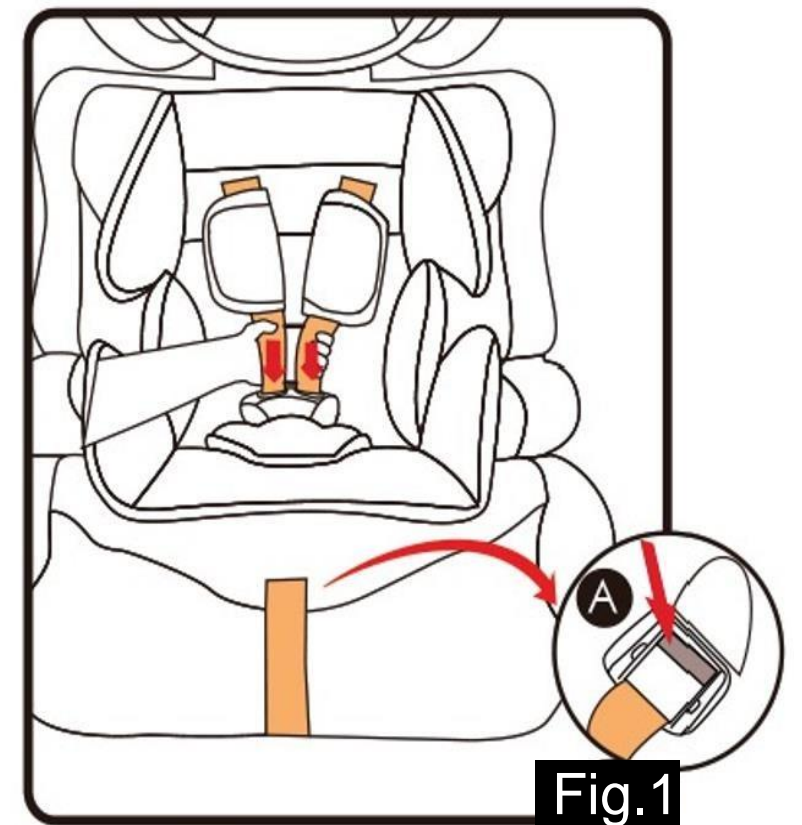

Fig.1

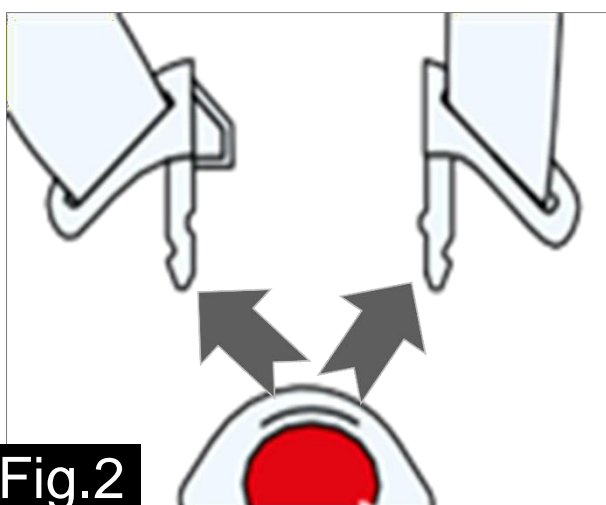

Fig.2

- Open the harness buckle, then place the harness straps to the sides of the car seat.

- Put the baby into the car seat.
- The correct belt height of the shoulder pads is attained when the strap disappears into the shell slightly above the shoulder of the child.
- *Make sure that the harness straps fit properly over the shoulders of the child.*



Fig.3

Fig.4



- Bring two buckle tongues together and insert them in the buckle with an audible sound "click".

3. How to Use the Product

3.5 Tightening the harness

- Pull the shoulder straps to eliminate slack in the waist section, so the internal safety harness lie flat.
- Tighten the safety harness straps with the adjustment strap until it lies flat on the child's body and close to it. Make sure the tightness is comfortable to your kid.
- A loose harness can be dangerous. Check the harness adjustment & tighten each time the child is placed in the seat.

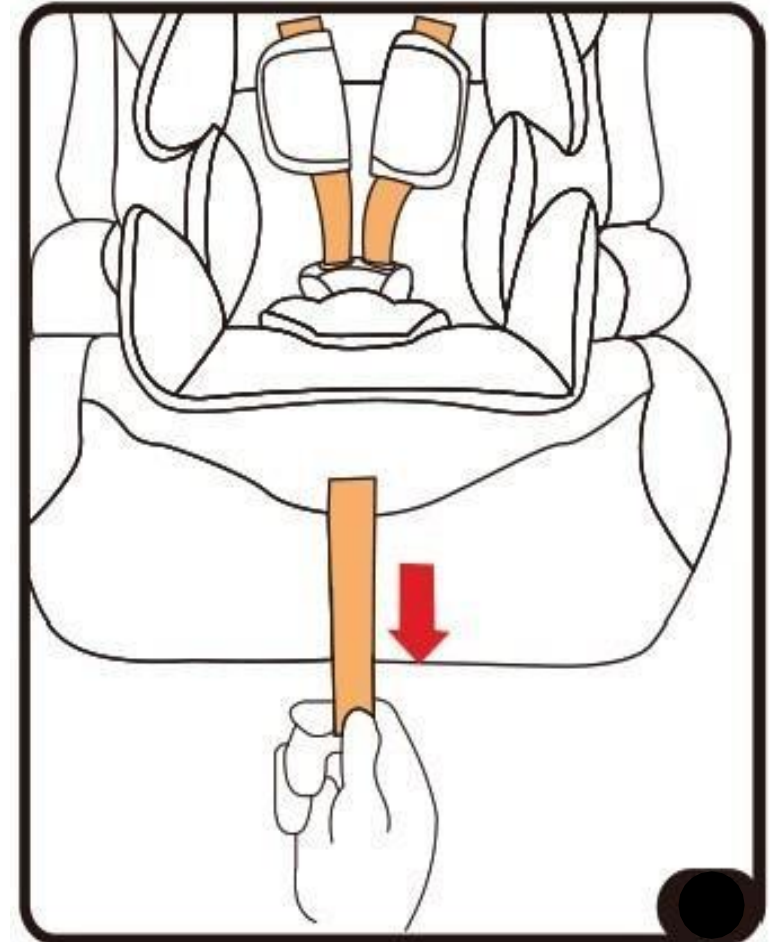

- **NOTE** :The waist internal safety harness straps must be positioned as low as possible on the child's hips.
- Please pay attention to the strap end. Whilst traveling (especially outside the car) it should always be attached to the cover.

CAUTION!

Do not twist or interchange the harness straps.

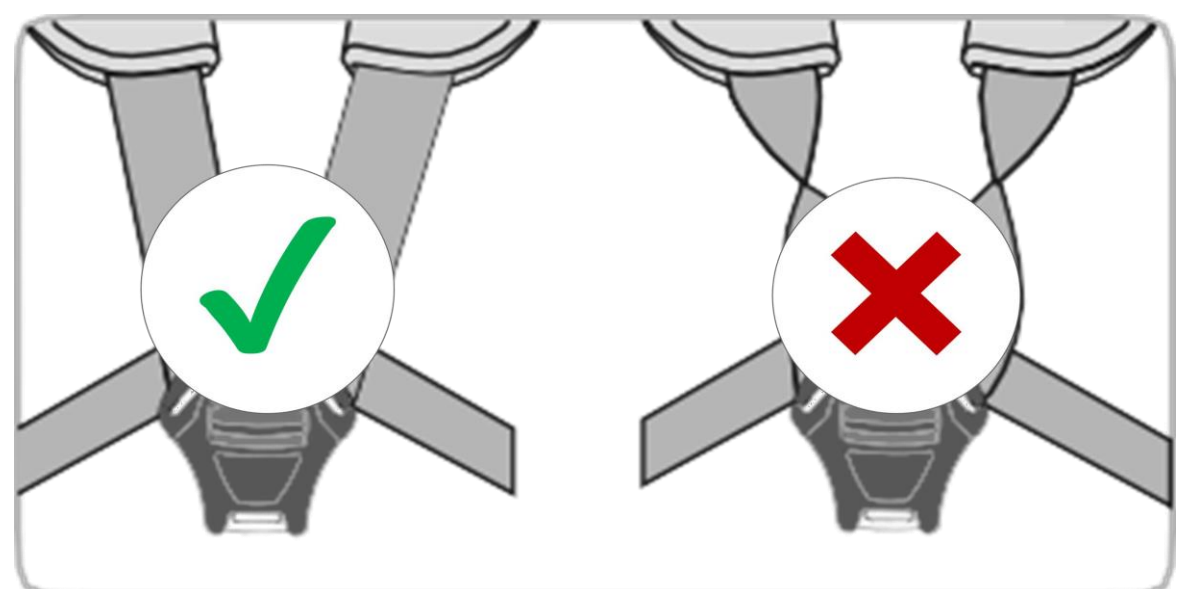

3.6 Checklist to ensure that your baby is buckle up correctly.

For the safety of your baby , please check that:

- The harness straps of the car seat are comfortable but firm fit around your child.
- The harness straps are adjusted correctly.
- The harness straps are not twisted.
- The buckle tongues are engaged in the harness buckle.

4. INSTALLATION



Please do not leave your child unattended in the child safety seat in the vehicle.

In the case of an emergency stop or an accident unsecured persons or objects may cause injury to other vehicle occupants. Please always check that:

- The backrests of the vehicle seats are locked (i.e. that a foldable rear seat bench latch is engaged).
- All heavy or sharp-edged objects in the vehicle (e.g. on the parcel shelf) are secured.
- All persons in the vehicle have their seat belts fastened.
- The child safety seat is always secured when it is in the vehicle, even if no child is being transported.

To protect your vehicle

Some vehicle seat covers of sensitive materials (e.g. velour, leather, etc.) may develop wear marks when child seats are used. This can be avoided by placing a blanket or towel under the child seat.

Special note:

- This product will reduce the harm of traffic accidents to children, but cannot guarantee the absolute safety of children, so when you driving, please strictly abide the local traffic laws and regulations
- This product has been approved with regulation UN Regulation No.129/03 series, for general use in vehicles and it will fit most, but not all car seats position.
- Please keep this instruction manual in good condition and read it thoroughly before use. It will help you to install the child safety seat correctly. Any incorrect installation may cause serious injury to your child. The manufacturer is not responsible for any danger caused by wrong installation.

4. INSTALLATION

4.1 Forward-facing car seat installation for children between 76 and 105 cm tall using a three-point car seat belt

4.1.1 Adjust the height of the shoulder straps and the headrest to the height of the child (see section 3.3).

4.1.2 Fixing the Car Seat



Fig.1

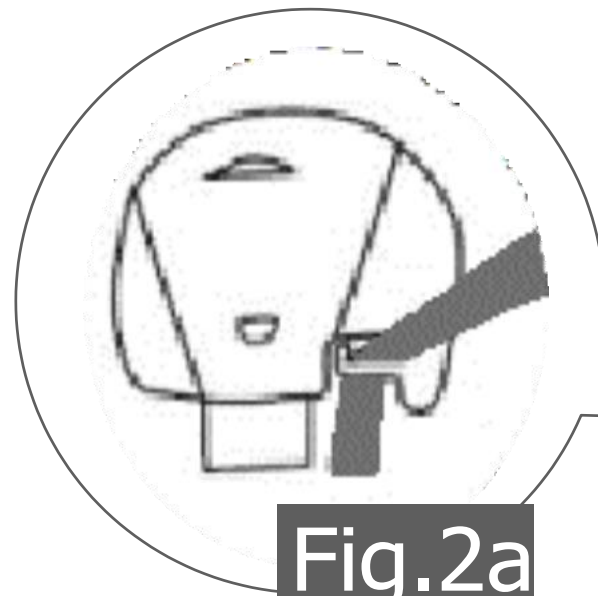

Fig.2a

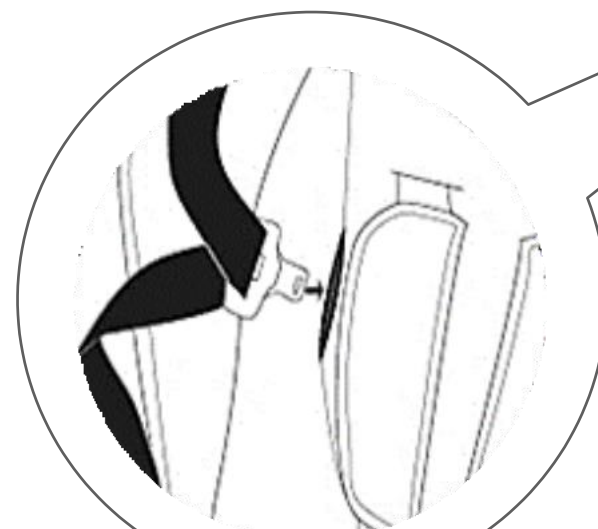

Fig.2b

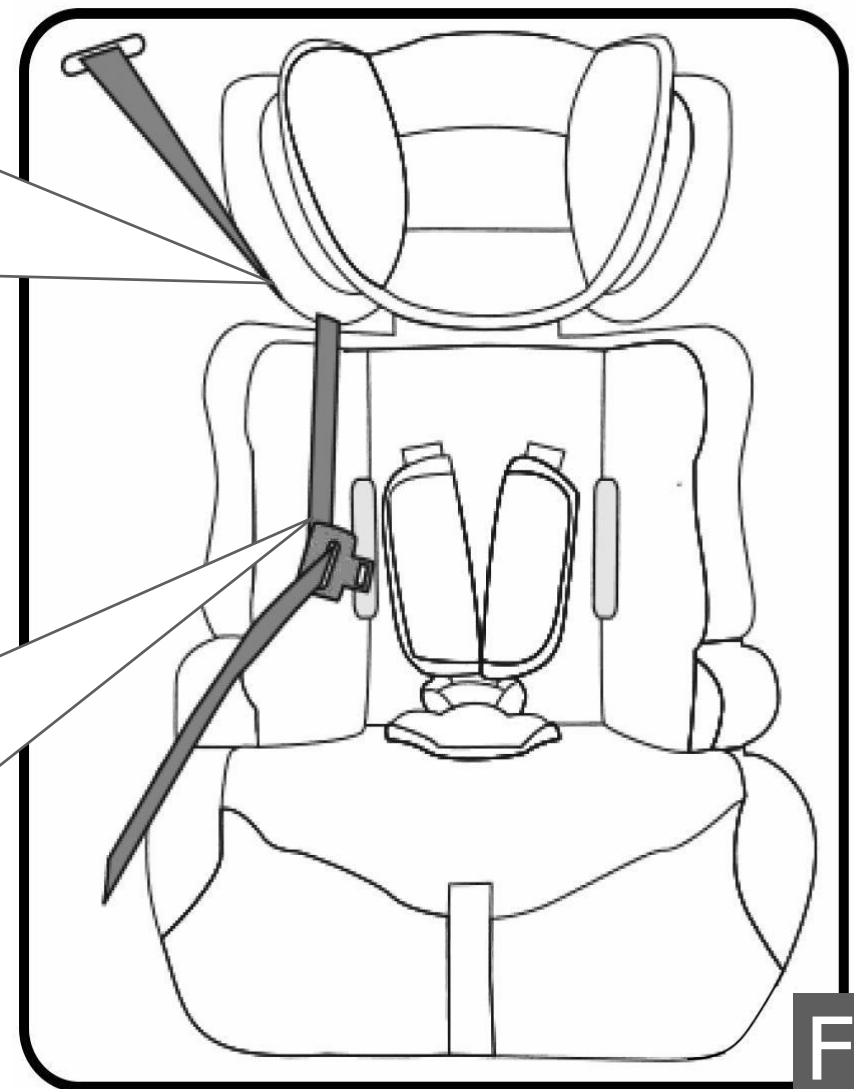

Fig.2

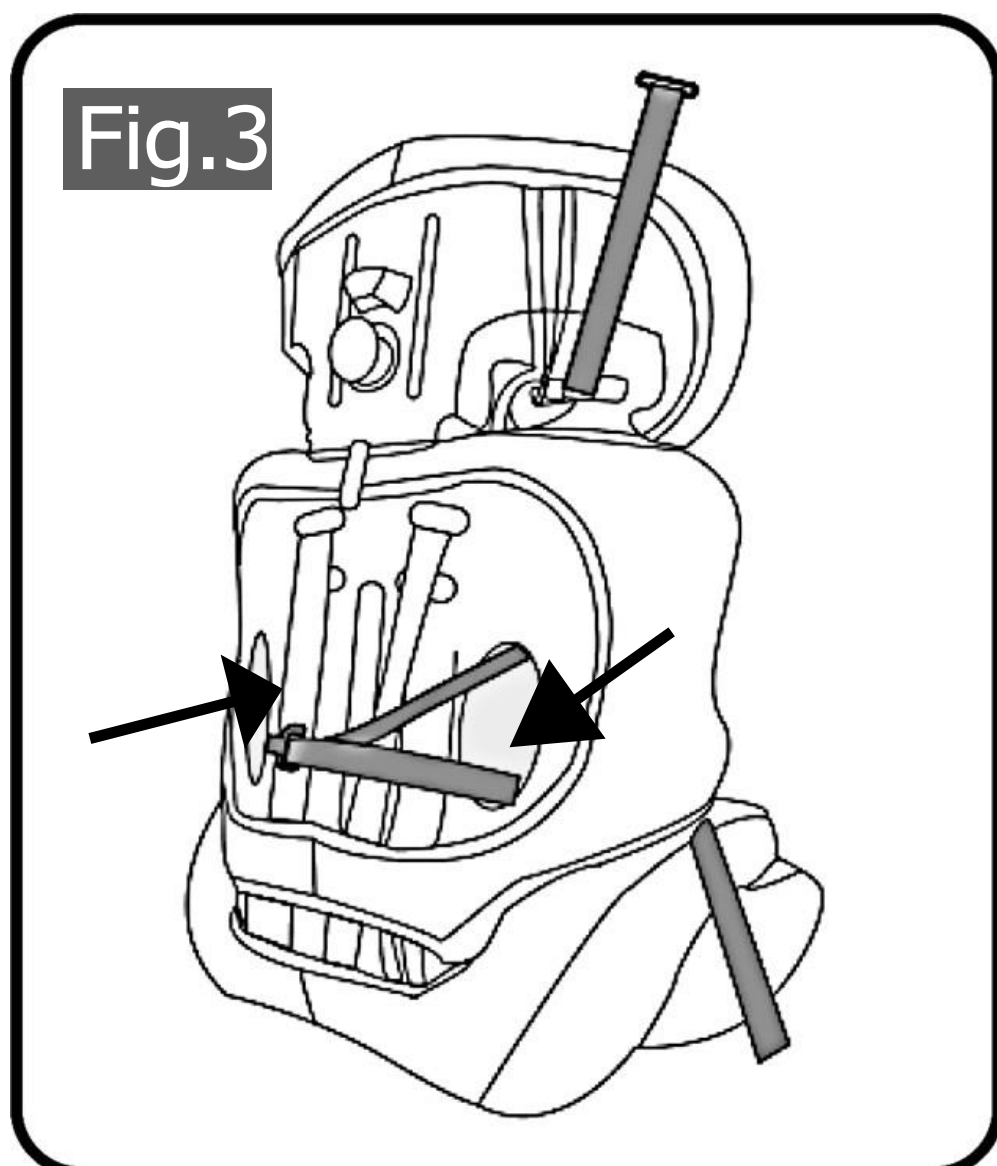

Fig.3

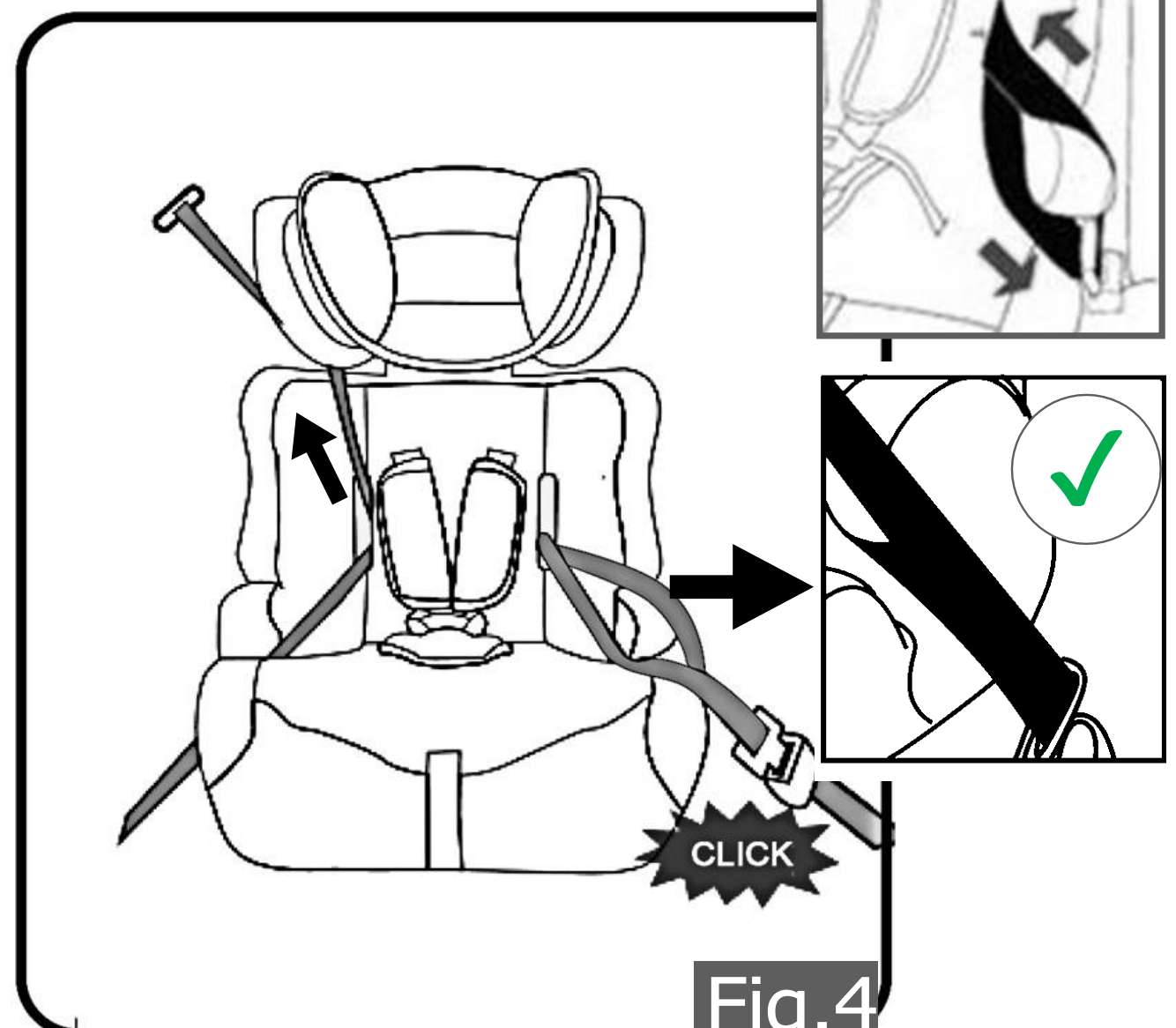

Fig.4

4. INSTALLATION

4.1 Forward-facing car seat installation for children between 76 and 105 cm tall using a three-point car seat belt

4.1.2 Fixing the Car Seat

- Step 1: Place the child safety seat on the vehicle seat ensuring it is firmly pressed against the seat backrest.
- Step 2: Pull the car seat belt (diagonal) under the seat belt guide. See Fig. 2a.
- Thread the seat belt through the fabric seat belt slot and the lap belt under the armrest of the booster. See Fig 2b.
- Step 3: Pass the seat belt through the seat belt slot (13), and further through the parallel seatbelt slot. (Fig.3)
- Step 4: Hook the seatbelt over the armrest of the booster seat (Fig.4), and lock the seat belt in place with Click sound. Tighten the seatbelts until the car seat is secure.

IMPORTANT! The car seat belts which hold the child safety seat must be tight. Pull the belts to tighten them up.

Proceed as described in section 3.4 and 3.5.

4.1.3 Loosening the belt (see section 3.4)

4.1.4 Place the child in the child seat and fasten belts (more details please see section 3.5)

- Step1: Loosen the belt, open the buckle and then put them aside.
- Step 2: Put the child on the safety seat, and then pass through the two straps on the child's shoulders.
- Step 3: Fasten the buckles
- Step 4: Pull the seat belt straps up from the connecting portion, and then pull the seat belt adjuster band until the belts are fastened.
- Step 5: Adjust the straps as tight as possible within the range of comfort.
- Step 6: Adjust the belts to be the tightest each time when children are placed on the seats, because it is dangerous without fastening it. Make sure that all belts wear least and the pelvis is fixed.

4. INSTALLATION

4.2 Forward-facing car seat installation for children between 100 and 125 cm tall using a three-point car seat belt

The child from this group must not be secured with the child safety seat belts. The child must be secured with 3-point Adult safety belts.

Before installing the car seat,

- **remove the safety harness of the car seat (see section 4.2.1).** Please remember: The baby insert and protective pads should be stored in a safe place for future use.
- **Adjust the headrest to the child's height (see section 3.3).**

4.2.1 Dismantling Safety Belts

- Step1: Unfasten the belt buckle and then turn the seat to rear.
- Step2: Loosen the belt from the connector
- Steps of installation and removal are completely opposite.
- Make sure that all parts of car seat belts are placed properly.

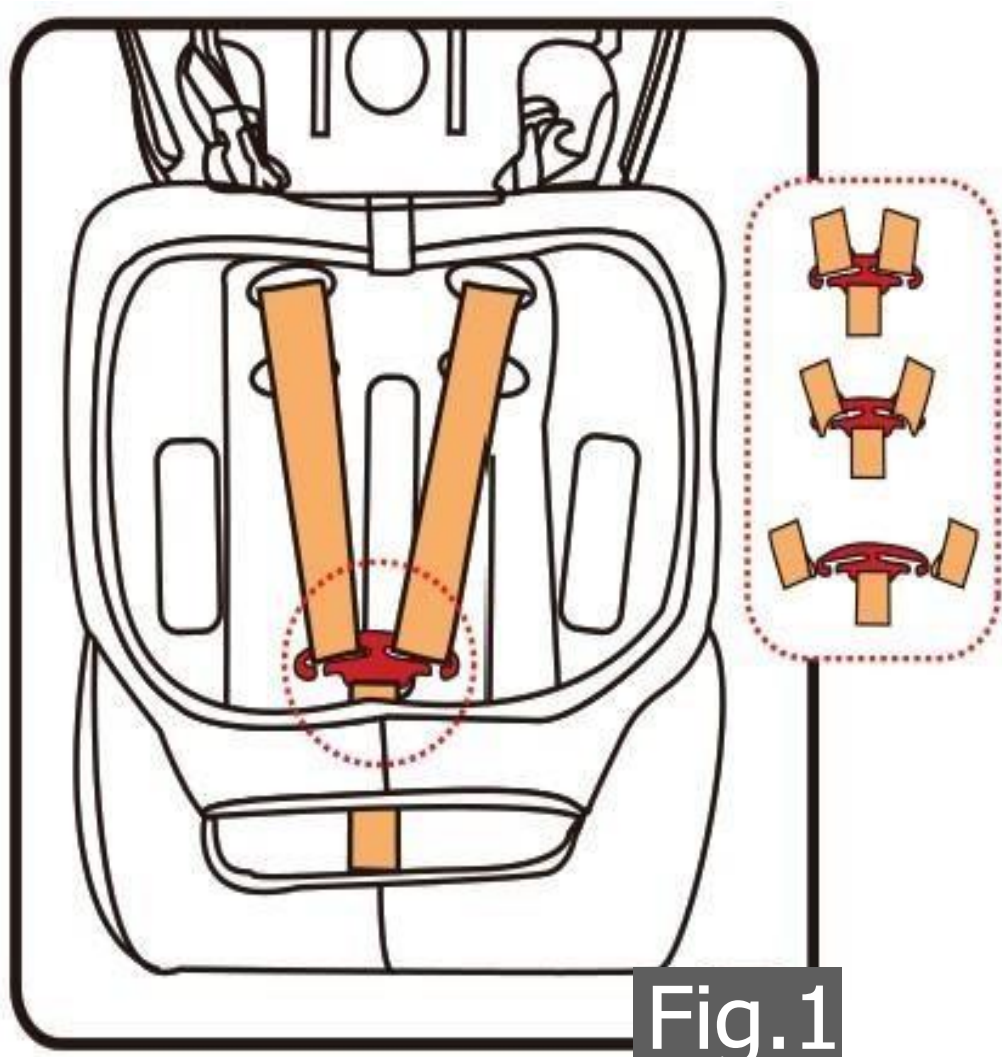

Fig.1

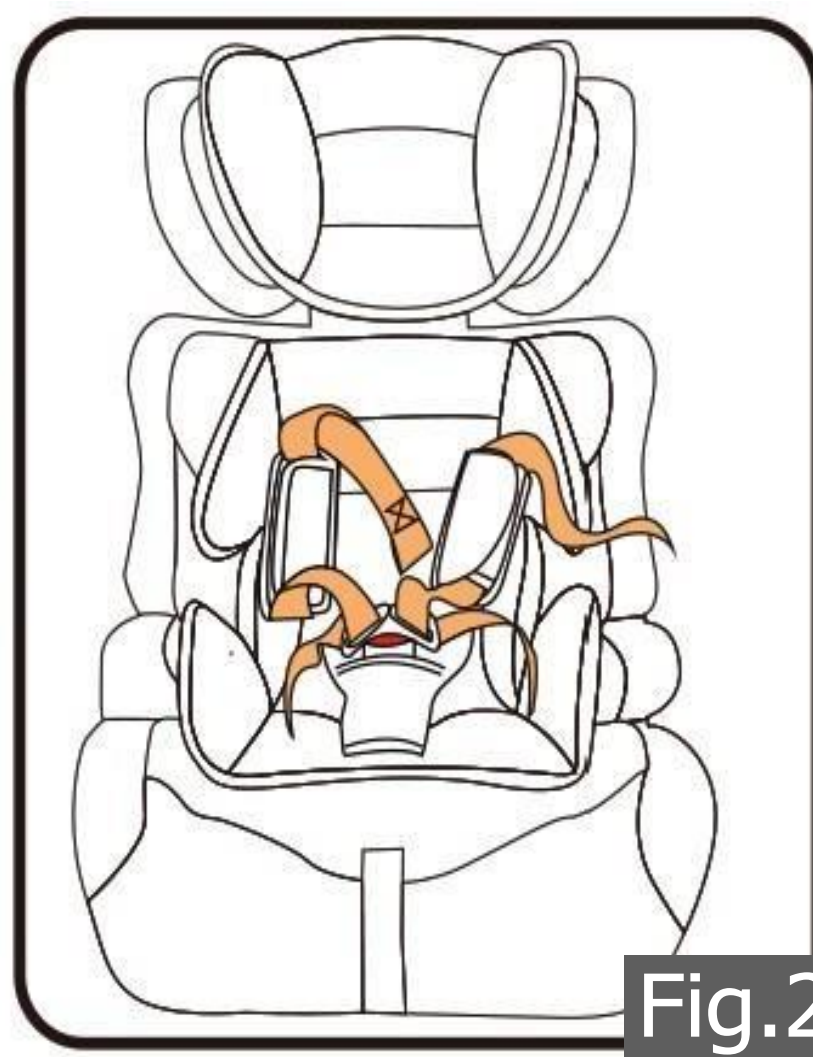

Fig.2

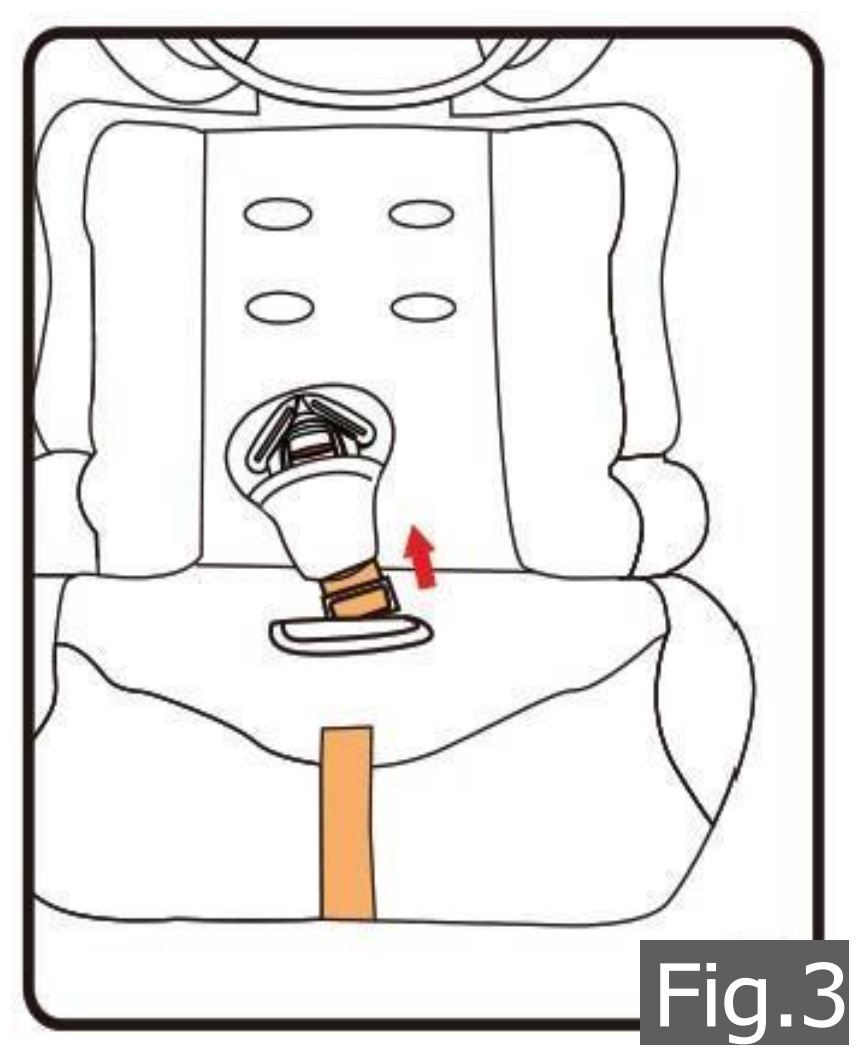

Fig.3

4. INSTALLATION

4.2 Forward-facing car seat installation for children between 100 and 125 cm tall using a three-point car seat belt.

4.2.2 Fixing the Car Seat with Belts

- Step 1: Place the child safety seat on the vehicle seat ensuring it is firmly pressed against the car seat backrest (Fig. 1).
- Step 2: put the child on the safety seat (Fig. 2).



Fig.1



Fig.2

- Step 3: Guide the car belt under the armrests (belt line marked in green) of the waist belt, making sure that both sections of the seat belt go under the armrests.
- **Make sure that the waist belt is positioned as low as possible over your child's hips, fits into the guides and that it is fastened with a buckle.**
- The diagonal belt goes through the belt guide on the side of the headrest (Fig.4). Fasten the vehicle seat belt, you will then hear a "click" (Fig 3 / Fig.4).
- **The shoulder belt should pass between the child's shoulder and neck.**
- Step 4: Tighten the seat belt by pulling the diagonal strap upwards. The belt cannot be twisted.

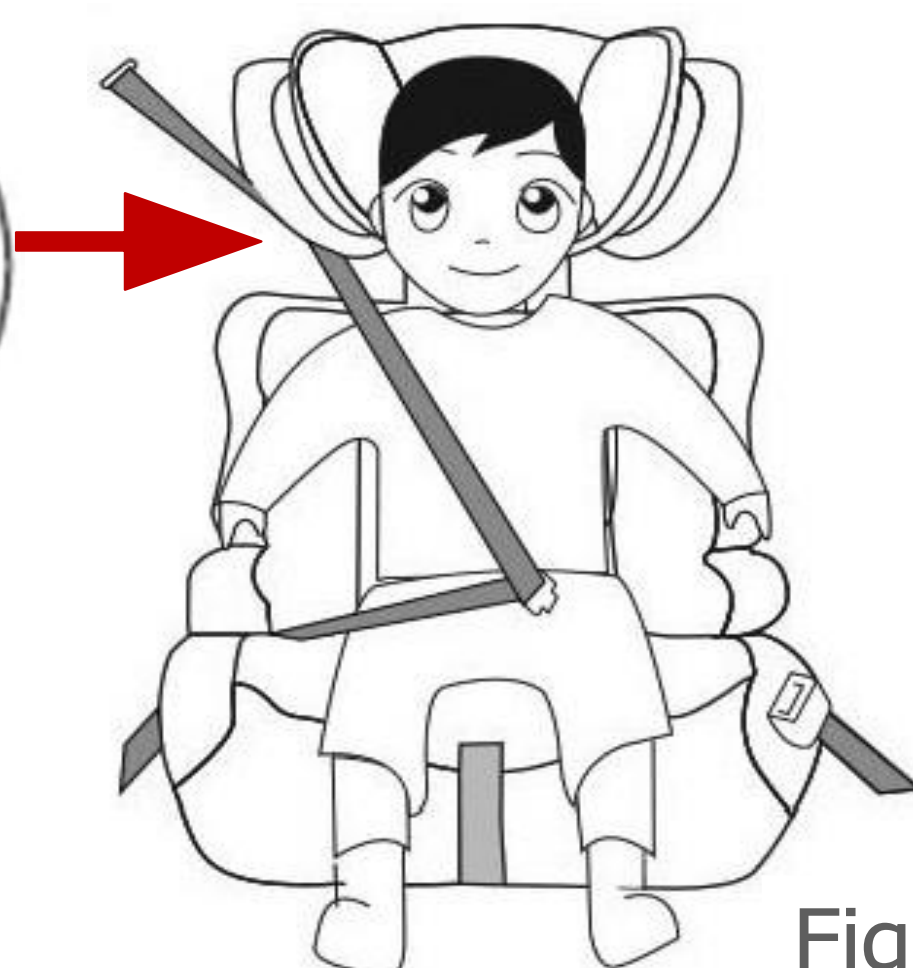

Fig.3



Fig.4

4. INSTALLATION

4.3 Forward-facing universal booster seat installation for children between 125 and 150 cm tall using a three-point car seat belt

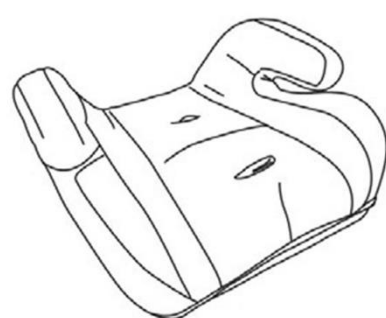

Fig.1

- Remove the backrest from the booster seat and place in a safe place, place with the other fittings.



Fig.2

- Place the booster seat on the seat of the vehicle ensuring it is firmly against the vehicle seat and backrest.



Fig.3

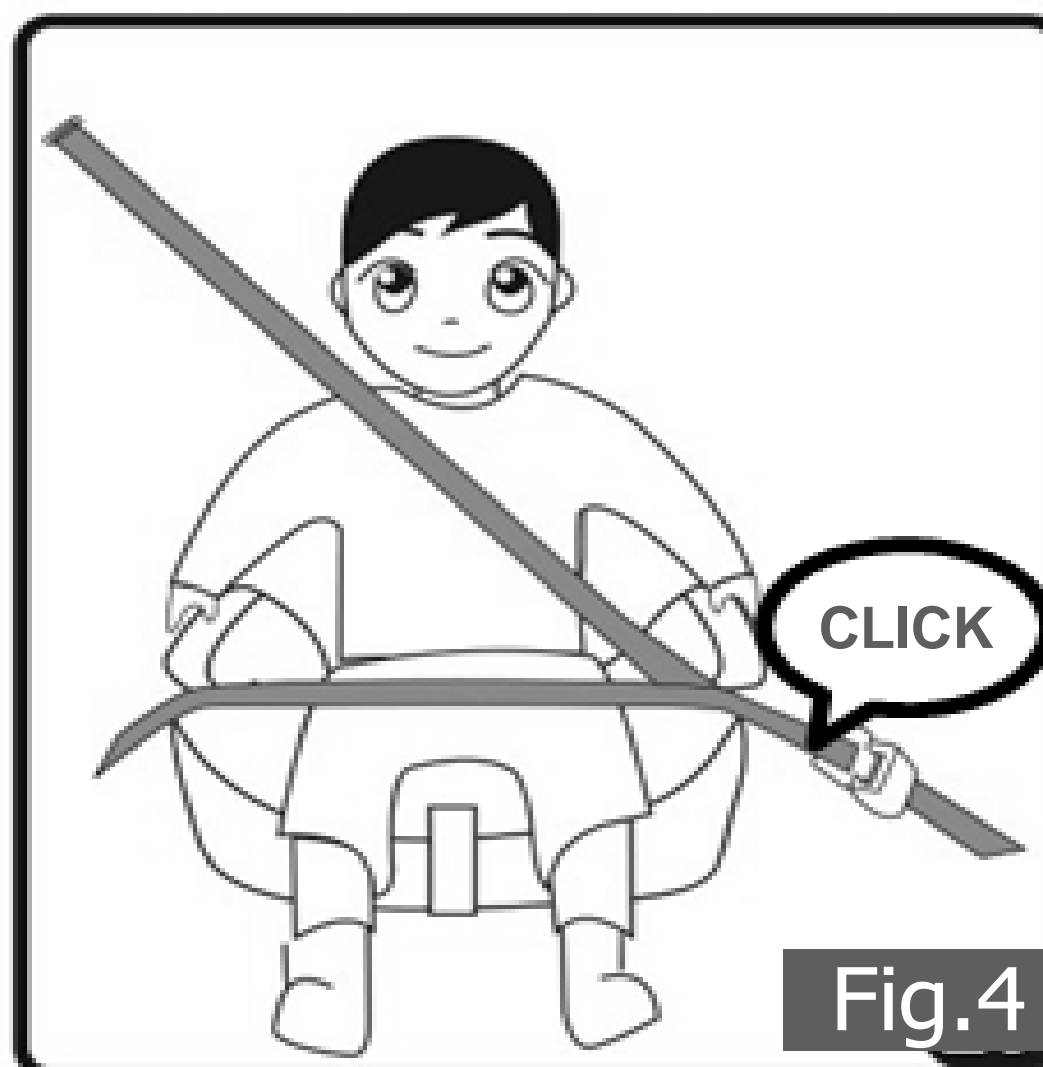

Fig.4

- Fasten the seat belt, making sure that the lap belt goes under both armrests and the diagonal belt goes under the armrest near the buckle. Make sure the belt is not twisted, and then tighten the seat belts by pulling the diagonal strap upwards.
- Check the seat belt to ensure there is no slack and the belt has not become twisted. Also check that the cover is not impeding the movement or fit of the seat belt in any way.
- To release the child, simply unfasten the seat belt in the normal way.

5. CARE INSTRUCTION

5.1 Cleaning

Please be sure to use only original seat covers, as the seat cover is important to the proper functioning of the system.



The child seat must not be used without the seat cover.

- The cover can be removed (see Fig.1) and washed with a mild detergent using the washing machine's cycle for delicate items (30°C). Please observe the instructions on the washing label of the cover. The colours of the cover may fade if washed at more than 30°C.
- Do not spin, and never tumble dry in an electric clothes dryer (the fabric may separate from the padding).
- The plastic parts can be cleaned using soapy water. Do not use harsh cleaning agents (such as solvents).
- The harness can be removed and washed in lukewarm soapy water.

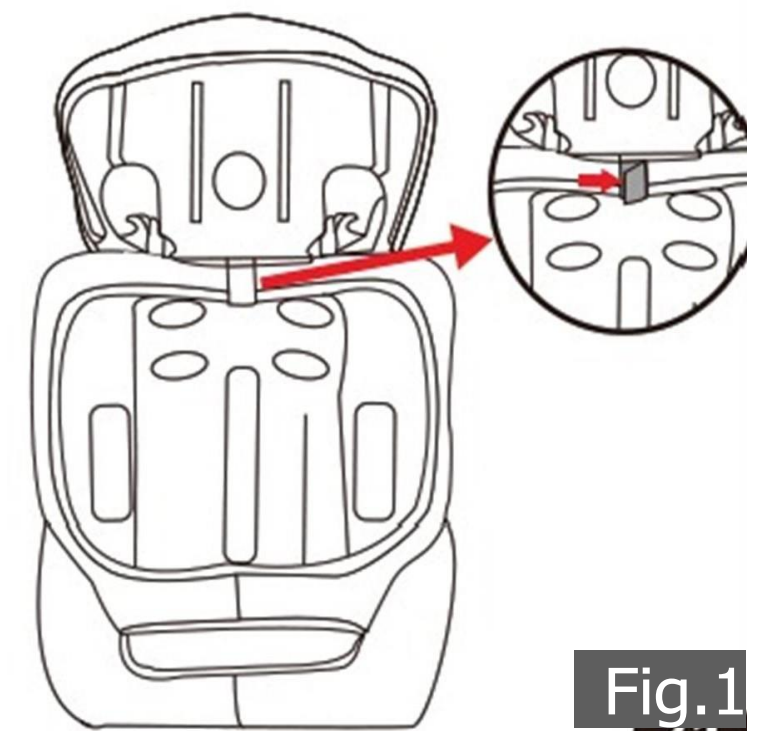

Fig.1



TEMPERATURE



DO NOT RINSE



NOT VERY HOT



NO DEHYDRATION



GENTLY RUB



LAY FLAT TO DRY

5.2 Checklist

For safety's sake read through this checklist before you set off.

- Check that the harness belt system fits properly and tightly around your child and that the shoulder belts are at the correct height.
- Check regularly that the belt in the baby car seat is not damaged. If it is damaged do not use your product in any circumstances.
- Check that you have secured your baby car seat with the seat belt.

6. Environmentally friendly disposal

Warning Danger of suffocation! Packaging material is dangerous for children. Never let children play with packaging material.

6.1 Disposal and packaging

The packaging of your unit consists of materials that are necessary to guarantee effective protection during transport. These materials are fully recyclable and therefore reduce the environmental impact. Dispose of the packaging in a bin for recyclable materials.

6.2 Disposal of old equipment

Old appliances must be disposed of in accordance with the guidelines and regulations of the local waste disposal authority. Check with your local administration for the address of the nearest recycling center and deliver your appliance there.

The real design of the products may differ from the pictures presented. All the pictures in this user guide are for reference only.

The product has been tested and meets all the requirements of the ECE R129 /03.



FableKids

love inspired.



Office address:
Fablekids
Gneisenaustraße 10-11
D-97074 Würzburg

Return address can be found in the imprint: <https://www.fable-kids.com>

VAT identification number: DE 263752326
Court of the Commercial Register is Würzburg, HRB 10082
WEEE Reg.-No. DE 61617071



Office address: FableKids • Gneisenaustraße 10-11 •
97074 Würzburg



Our customer service number:
Tel. +44 (0) 208 068 5604



E-Mail: info@fable-kids.com



Return address can be found in the imprint: <https://www.fable-kids.com>