

FableKids

love inspired.



Tricycle

EMMA



Thank you for choosing Fable Kids.

Please read the instructions carefully before use and keep for future reference.

Table of Contents

<u>1. Product Overview</u>	1
<u>2. Important Safety Information</u>	2
<u>3. How to Use the Product</u>	3
<u>4. Maintenance and Care</u>	6
<u>5. Environmentally Friendly Disposal</u>	7
<u>6. EU Declaration of conformity</u>	8



Dear Parents,
Thank you for purchasing our product. Please read the operating instructions carefully before using the product for the first time. If you give the product to a third party, this manual must be handed over with it. Keep the instruction manual for future reference. The drawings in this manual may not match the physical objects. Please refer to the physical objects.

1. Product Overview

1.1 Configurations 3IN1



**Baby Tricycle -
Parent Handle.**



Kids Trike



Balance Bike

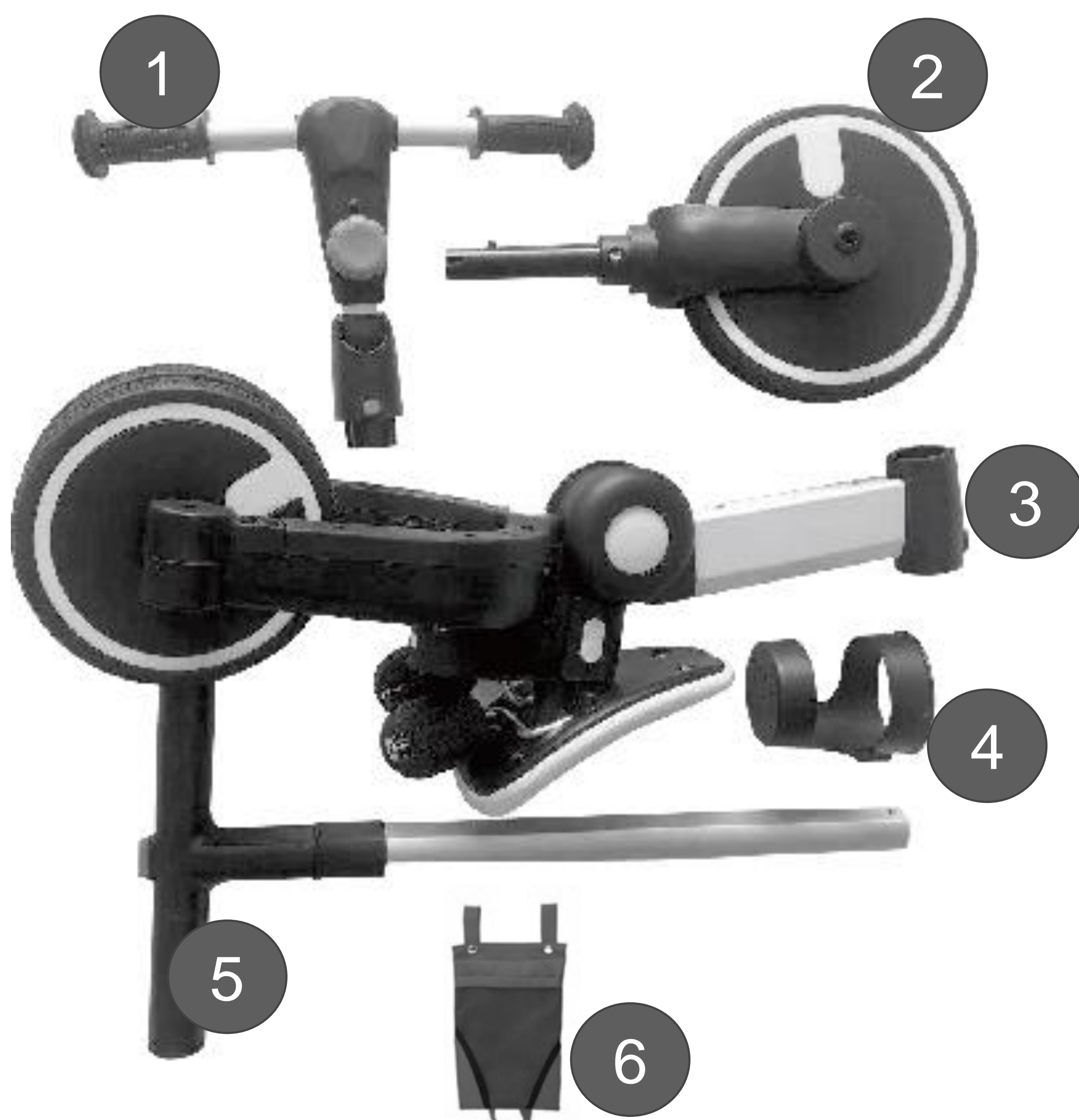

1.2 Part list

1. Handlebar
2. Front wheel
3. Frame
4. Cup holder
5. Parent handle
6. Rear bag

2. Important Safety Information



WARNING

Users and guardians are advised to read the instruction manual carefully before use and to keep it for future reference, as it may affect the safety of the child if used not in accordance with the instructions.

- **Warning!** TO AVOID SERIOUS INJURY: Continuous adult supervision required; never use near motor vehicles; never use near streets, swimming pools, hills, steps, or sloped driveways; Always wear shoes when using the product. Never allow more than 1 rider.
- **Warning!** Adult assembly required. Choking hazard to children under the age of 3 year - contains small parts prior to assembly.
- The maximum load capacity is 25 kgs.
- The applicable age is 18-60 months;
- **NO OVERLOADING!** Overloading or incorrect use, or the use of incorrect spare parts, may cause damage to the tricycle or make it unsafe.
- Do not hang anything on the handlebar as this may affect the stability of the tricycle.
- Stop using immediately if it is damaged or unstable.
- Must keep the kid in sight when using the tricycle;
- Do not use in dangerous places such as rugged streets, street roads, slopes, pools, etc., as it may cause traffic accidents or drowning.
- Do not put any parts of the body including hands, head and feet under the wheel.
- Do not allow more than one rider on the product at a time.
- This tricycle may have potentially sharp edges, pointy points or small parts before assembly and must be assembled by the adults. Children must wear shoes and protective gear and helmets while riding.
- Be sure the rider keeps both hands on the handlebars for proper control.
- Keep away from fire.

3. How to Use the Product

3.1 Instruction(Baby Tricycle)

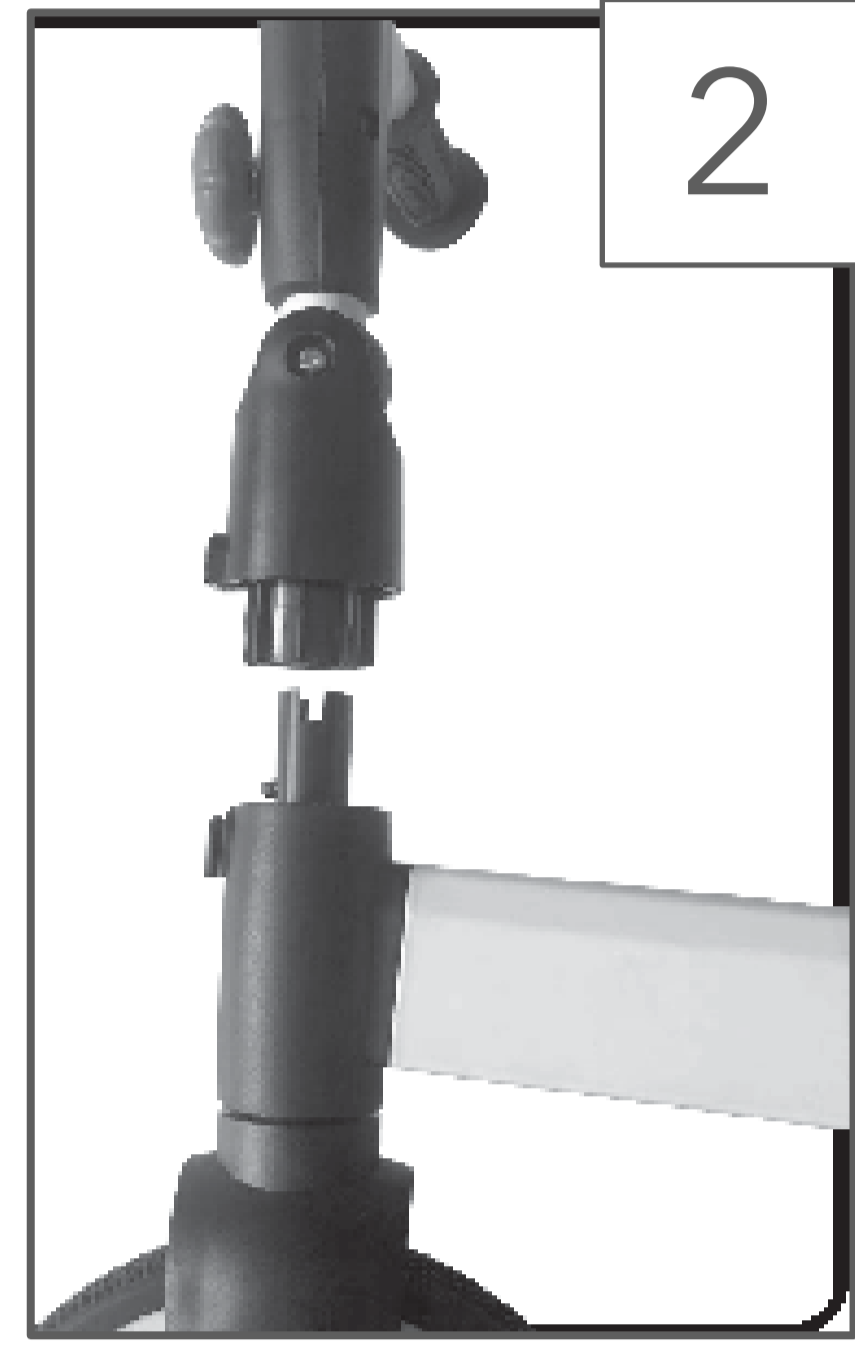

(Baby Tricycle - Parent Handle)

1. Inset the front wheel into the front of the frame.
2. Insert handlebar into the upright tube of the front wheel.
3. Assemble cup holder on the front of frame.

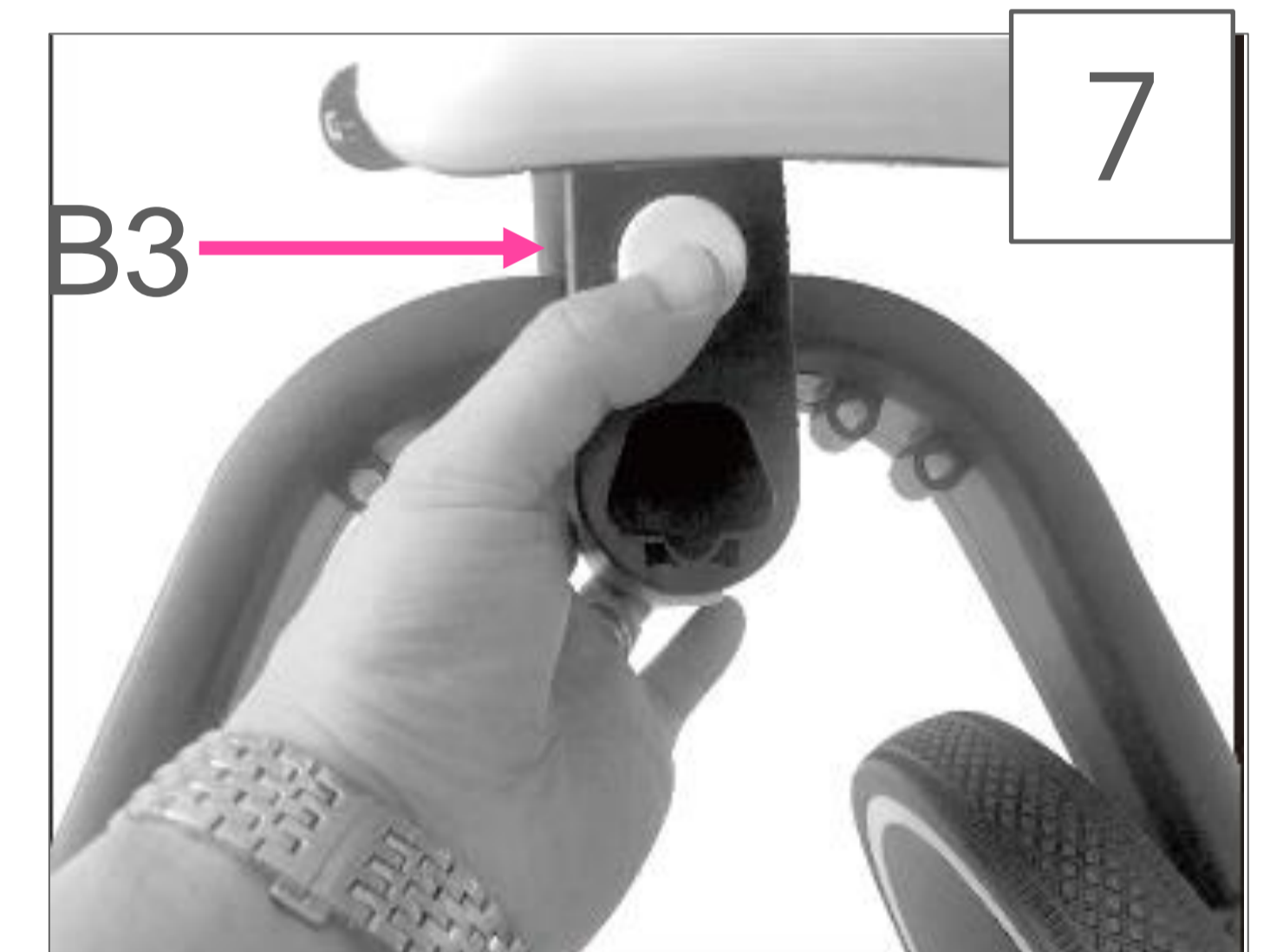
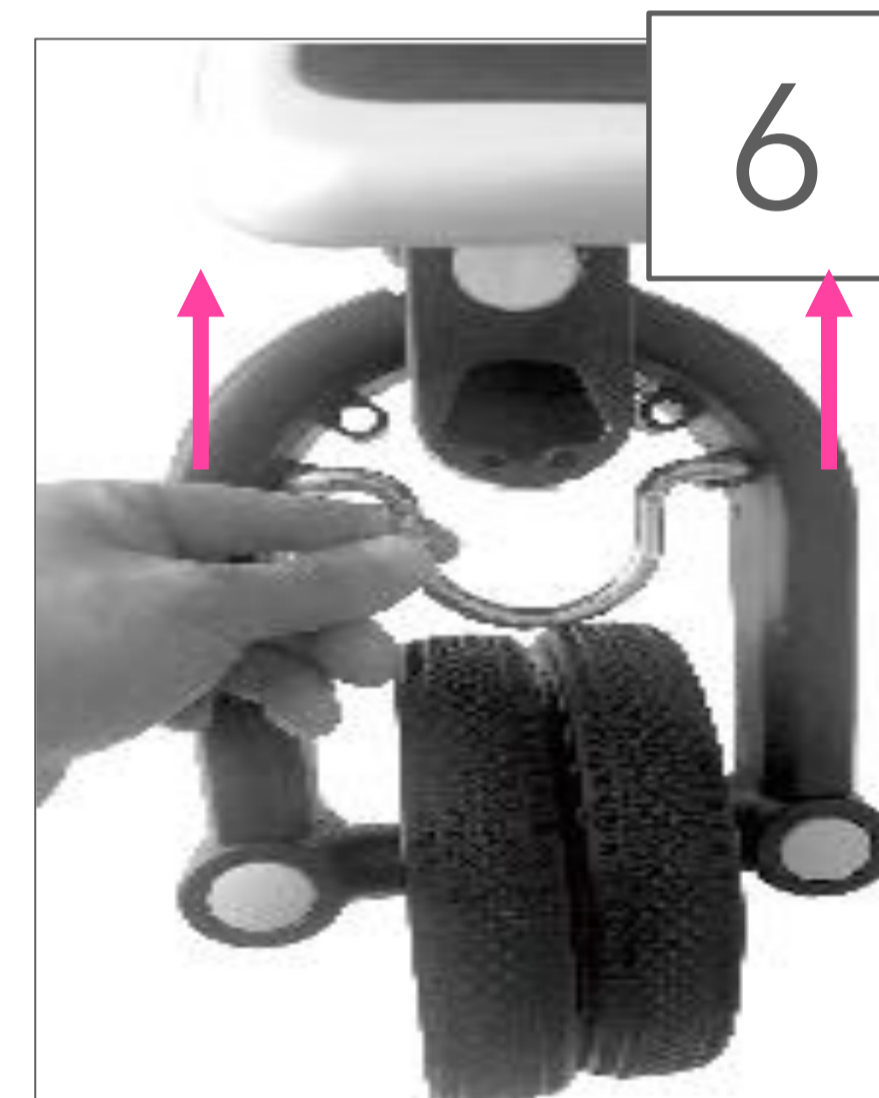
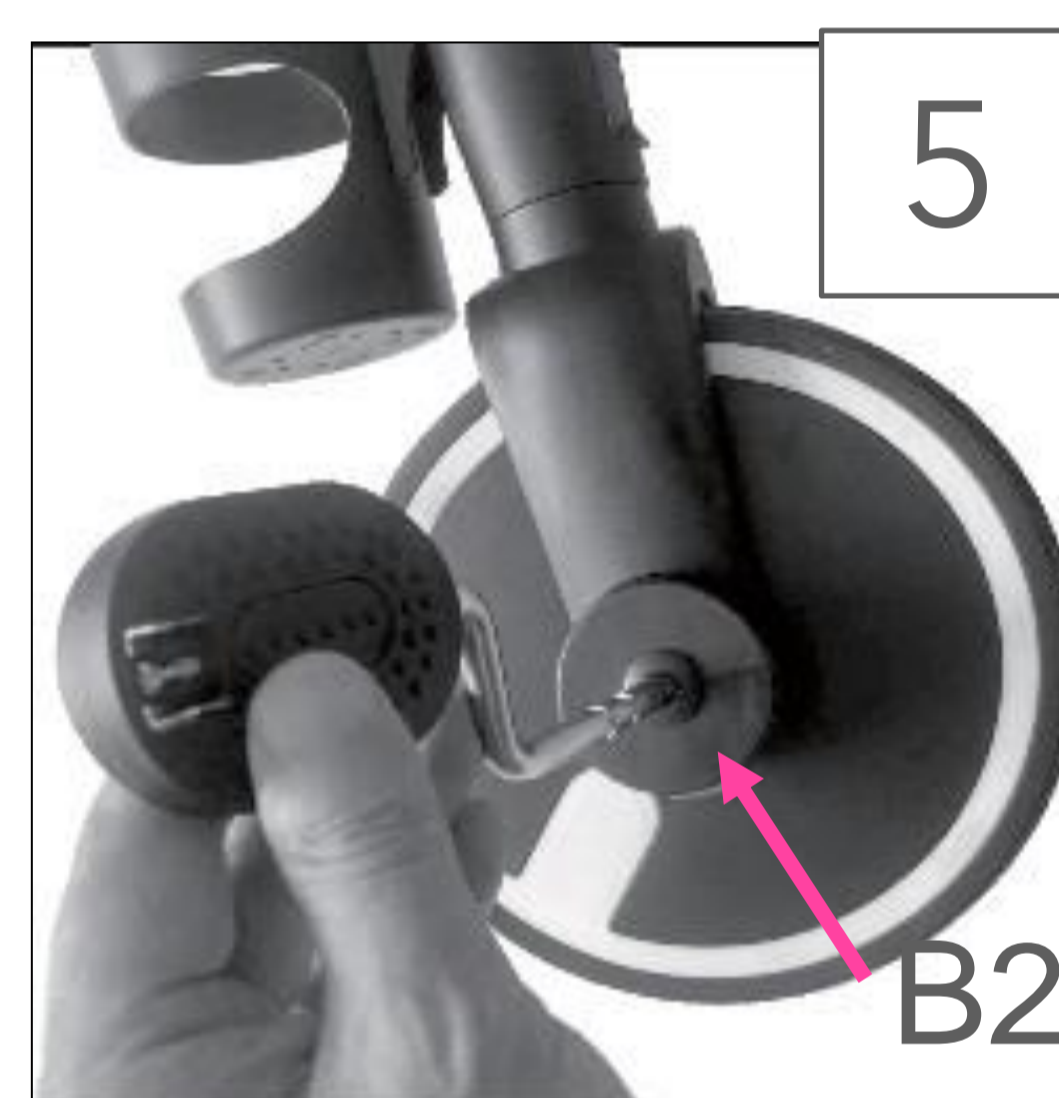
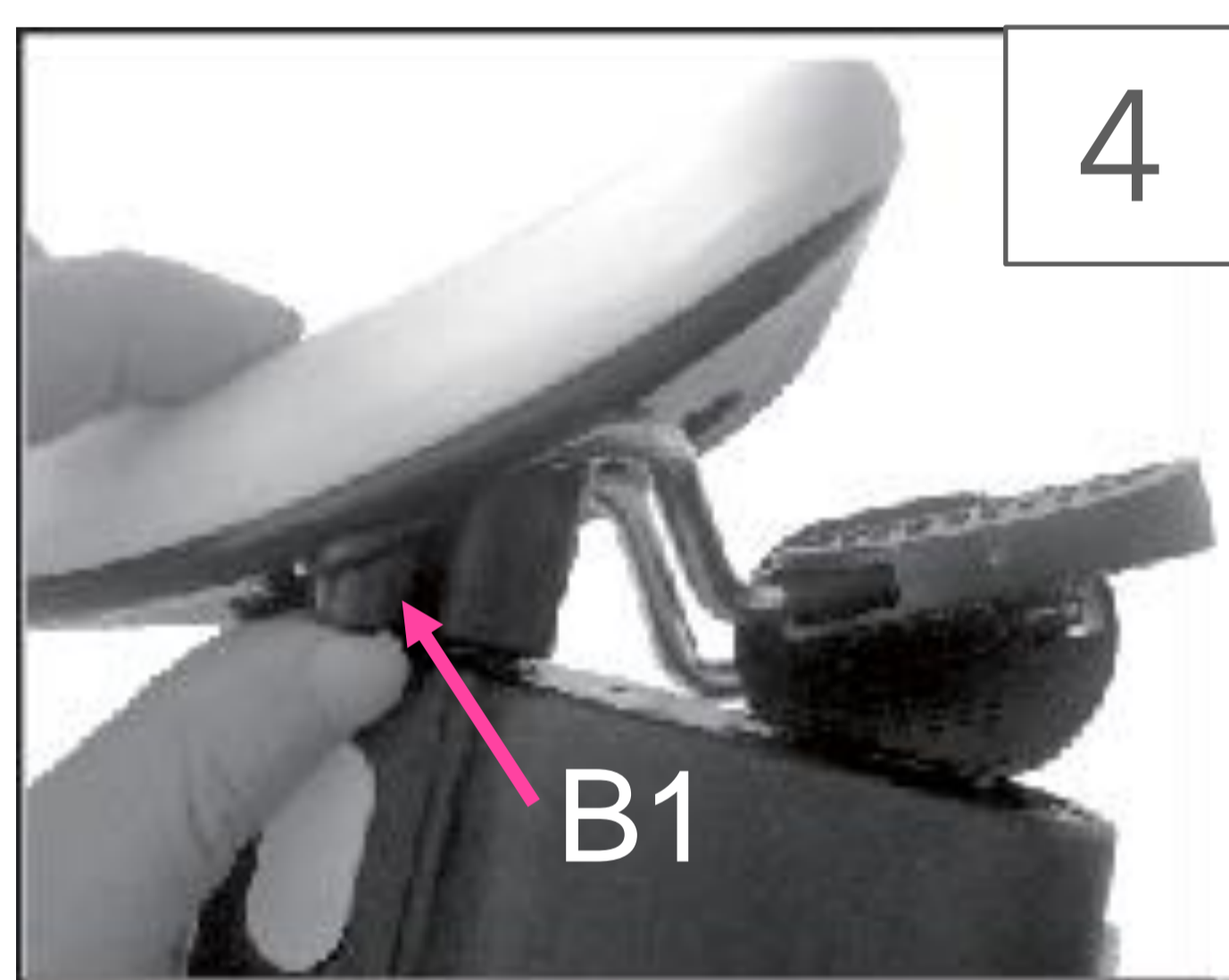

4. Press button B1, release pedals.
5. Press button B2, insert pedals into second gear.
- Please make sure that pedals do not turn with the wheels.**
6. Take out metal connecting rod upward.
7. Press upper button of B3, open the left rear frame; press lower button of B3. open the right rear frame

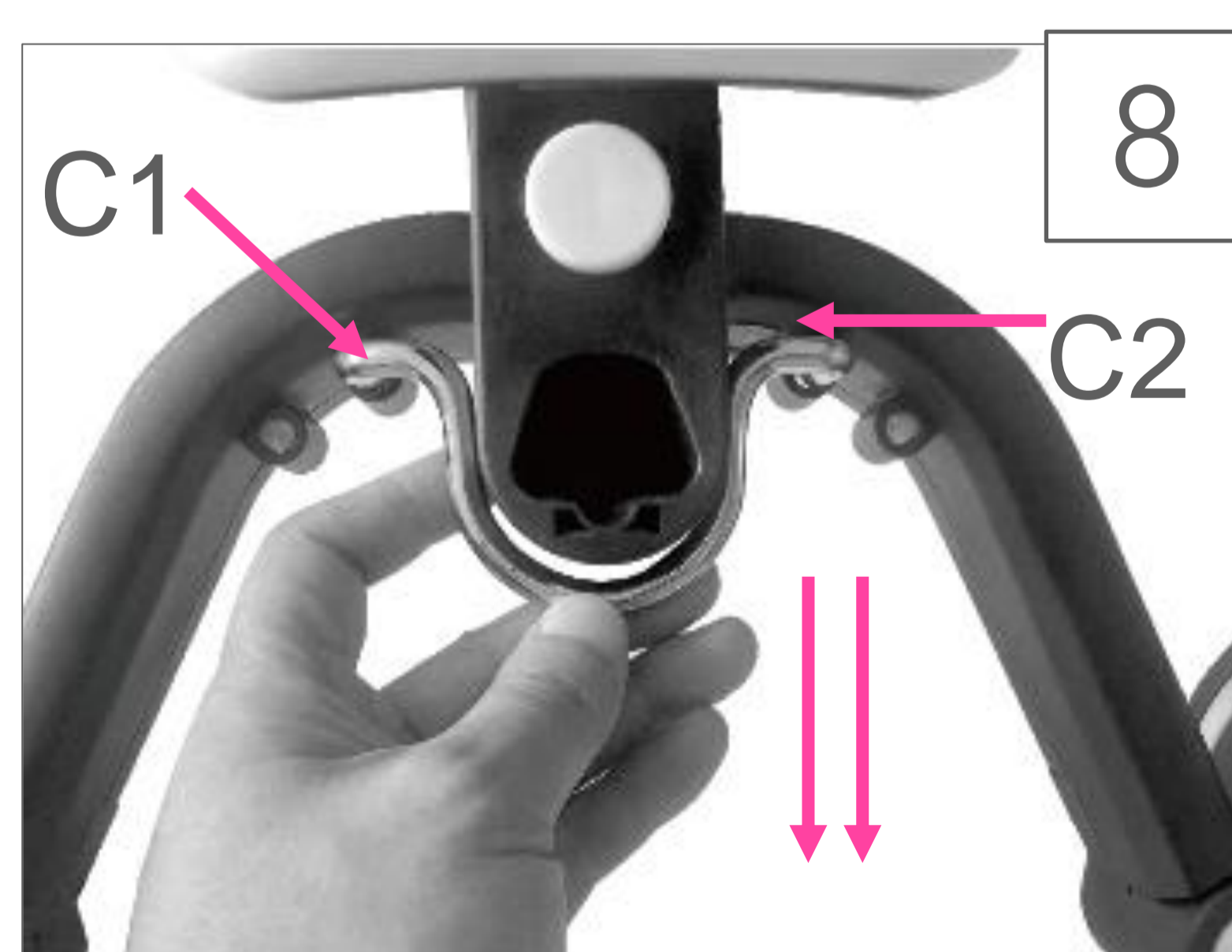

8. Assemble metal connecting rod on between C1 and C2.
9. Press button B4 on both side, turn the wheels outwards.
10. Insert parent handle into designated slot of rear frame.
11. To attach the rear pouch to the push rod by simply locking the button around the push rod handle.

3. How to Use the Product

3.2 Instruction(Balance Bike)

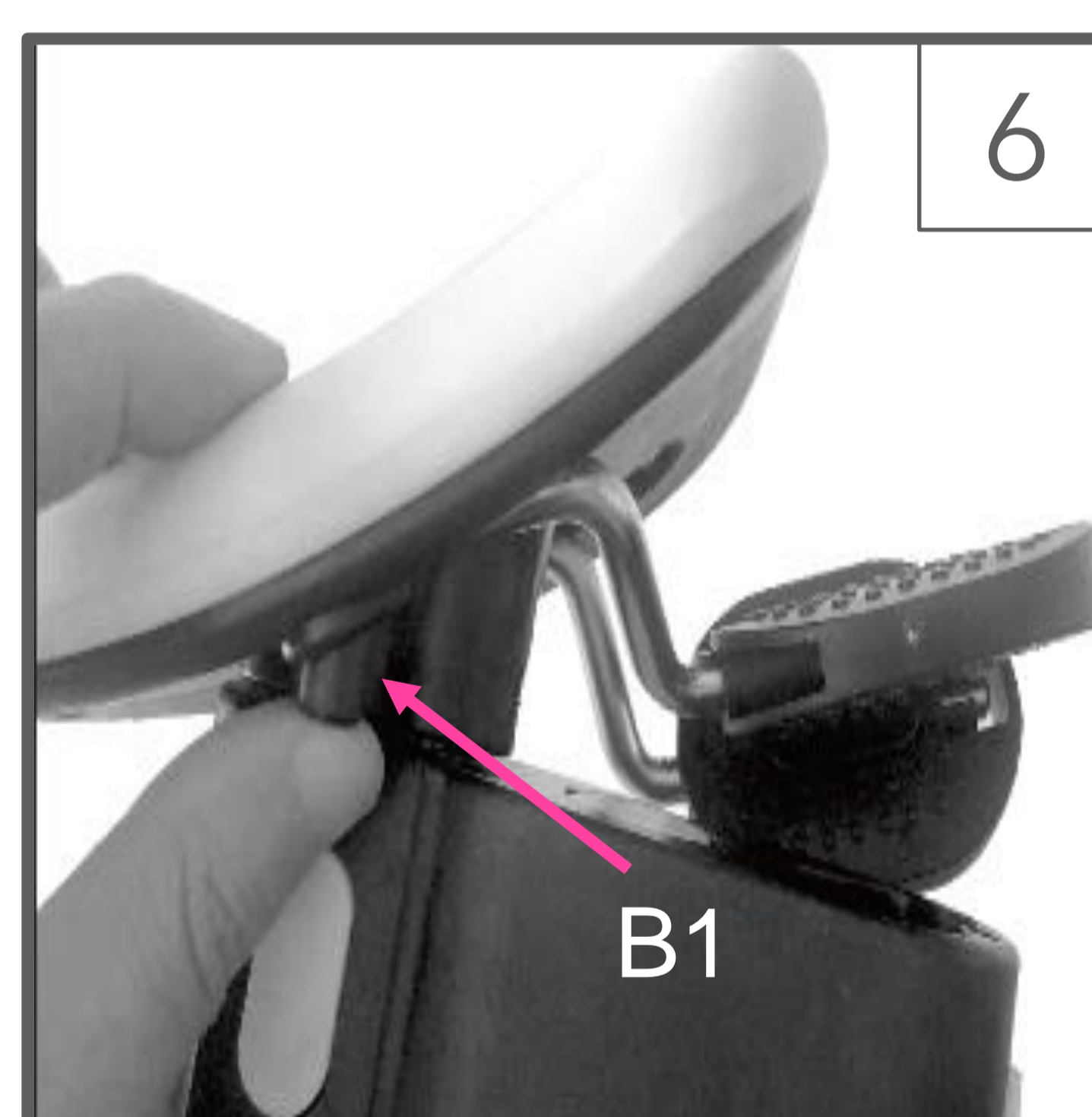
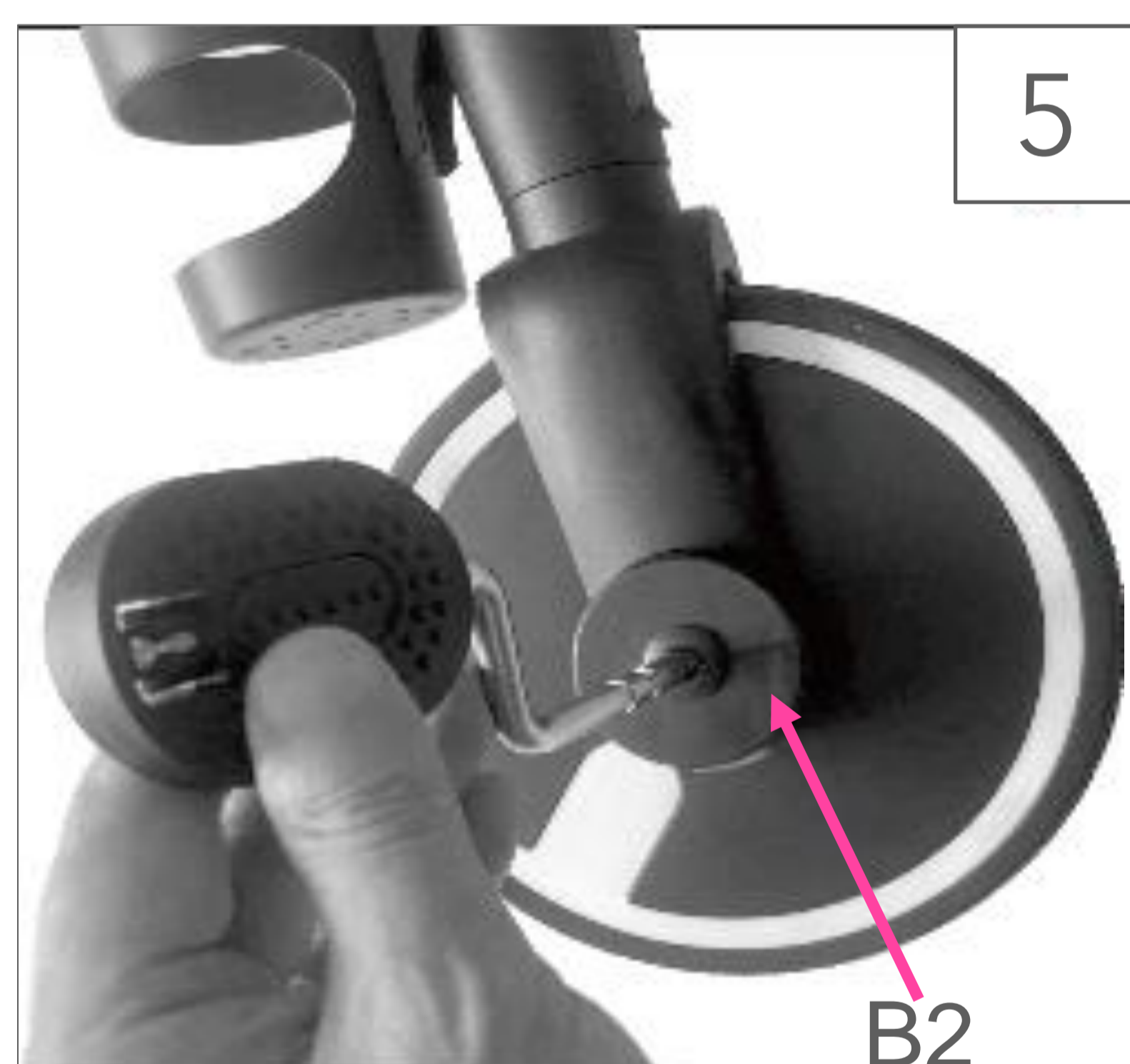
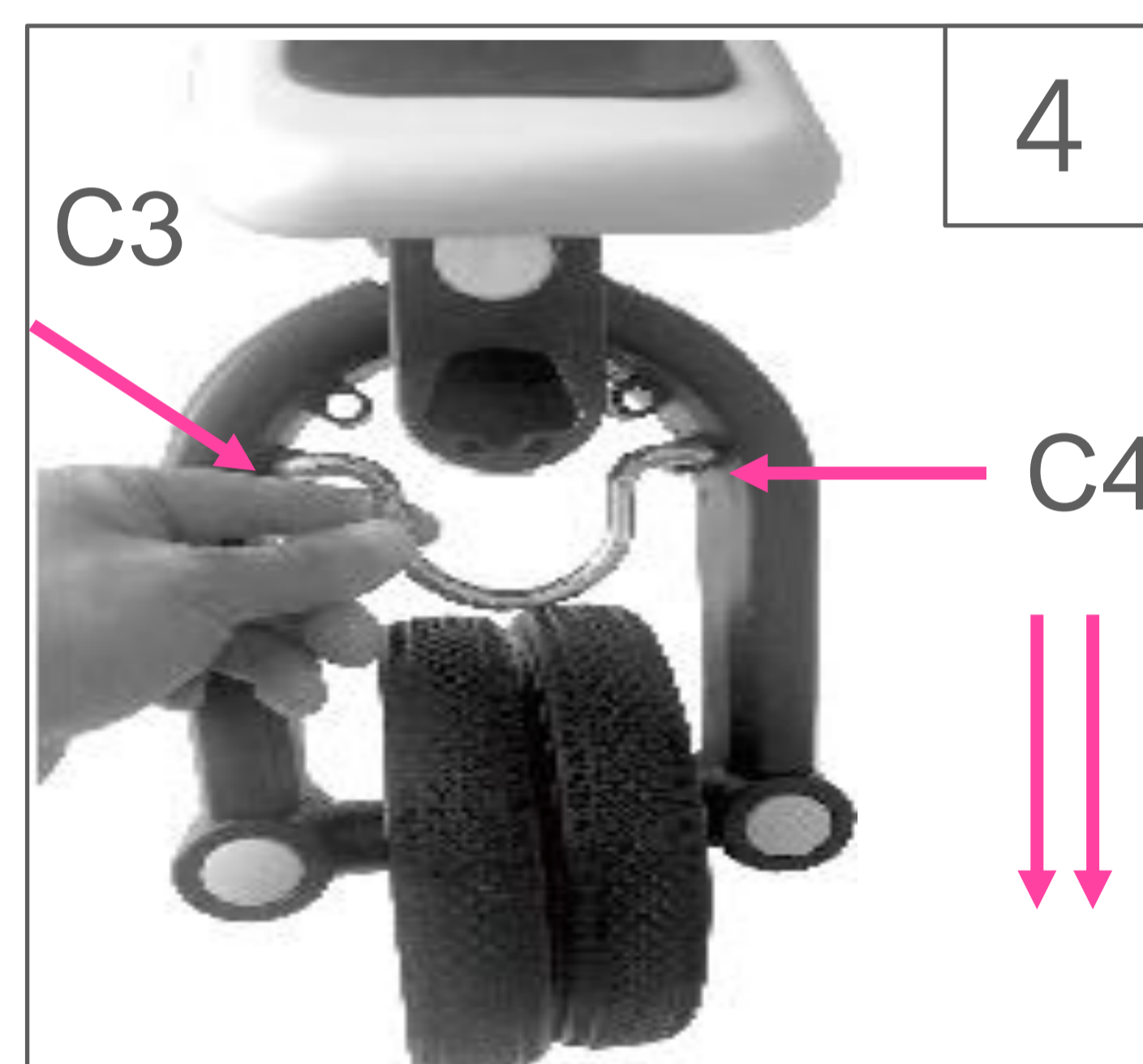
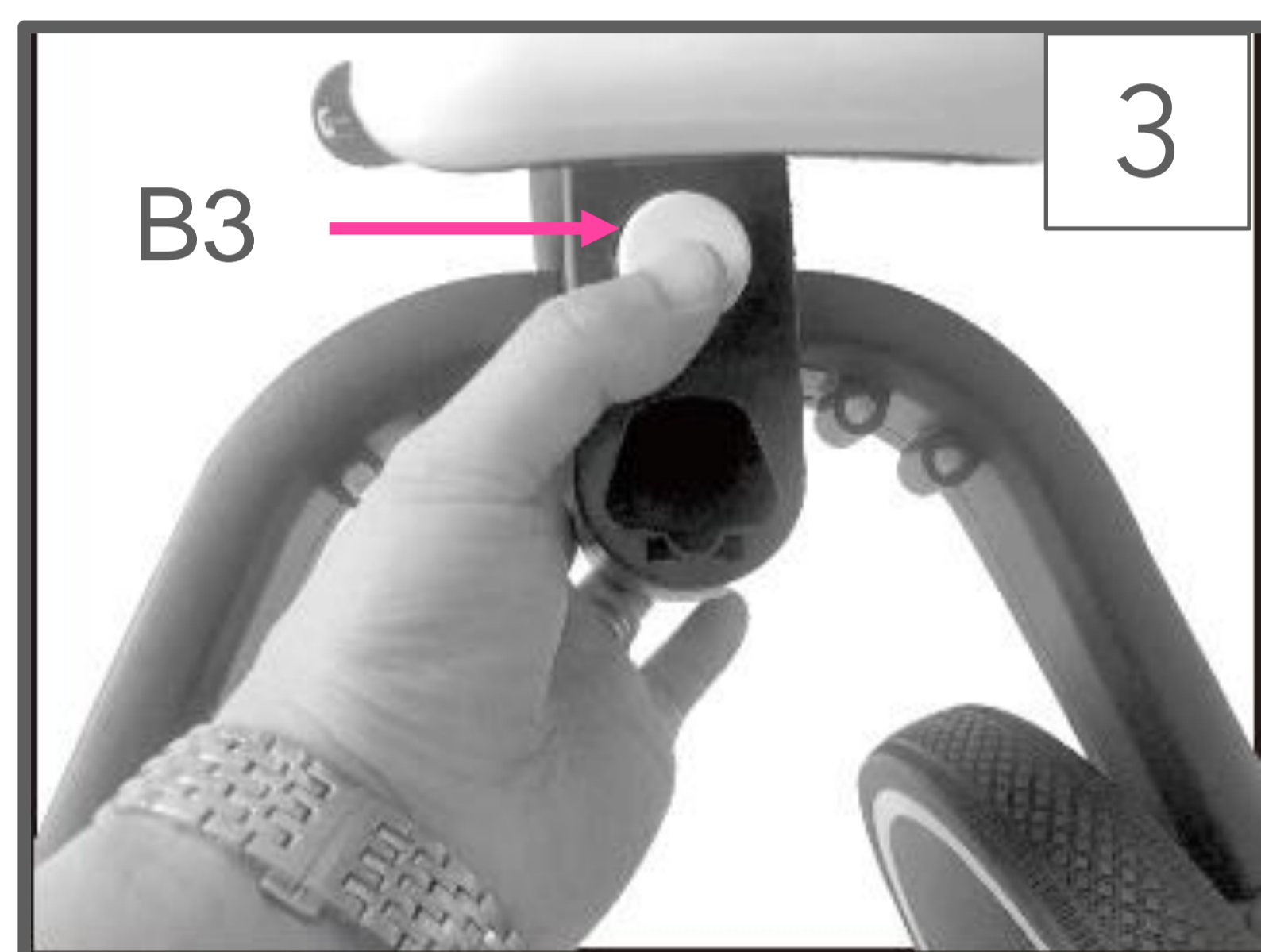
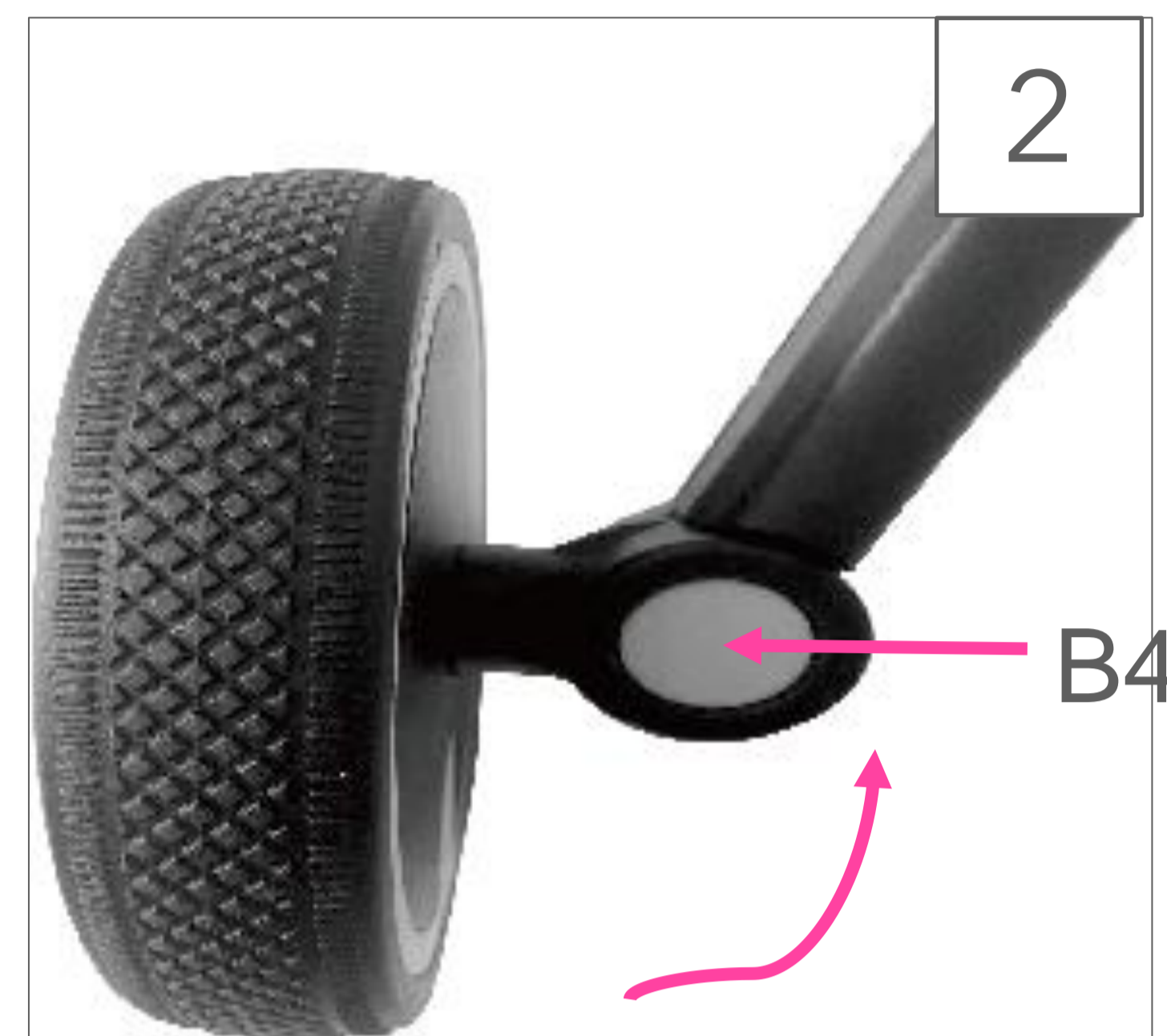
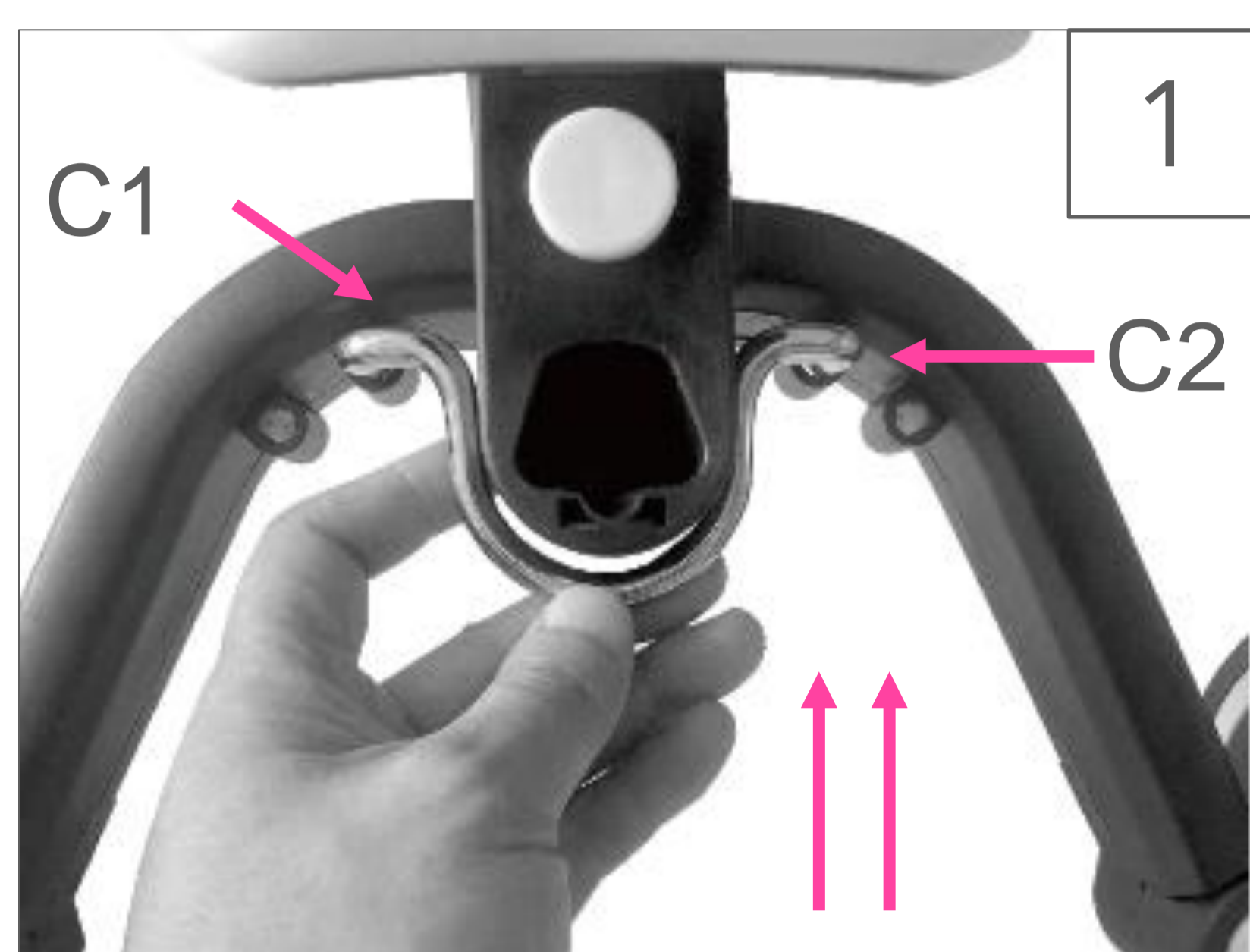

1. Take out metal connecting rod upward.
2. Press button B4, turn the wheels to the inwards until a click sound is heard
3. Press upper button B3, close the left frame and hear a click sound; press lower button B3, close the right frame and hear a click sound.
4. Insert metal connecting rod between C3 and C4. Make sure the locking is secured.
5. Press button B2, take out pedals.
6. Press button B1, insert pedals to store.

3. How to Use the Product

3.3 How to fold the trike

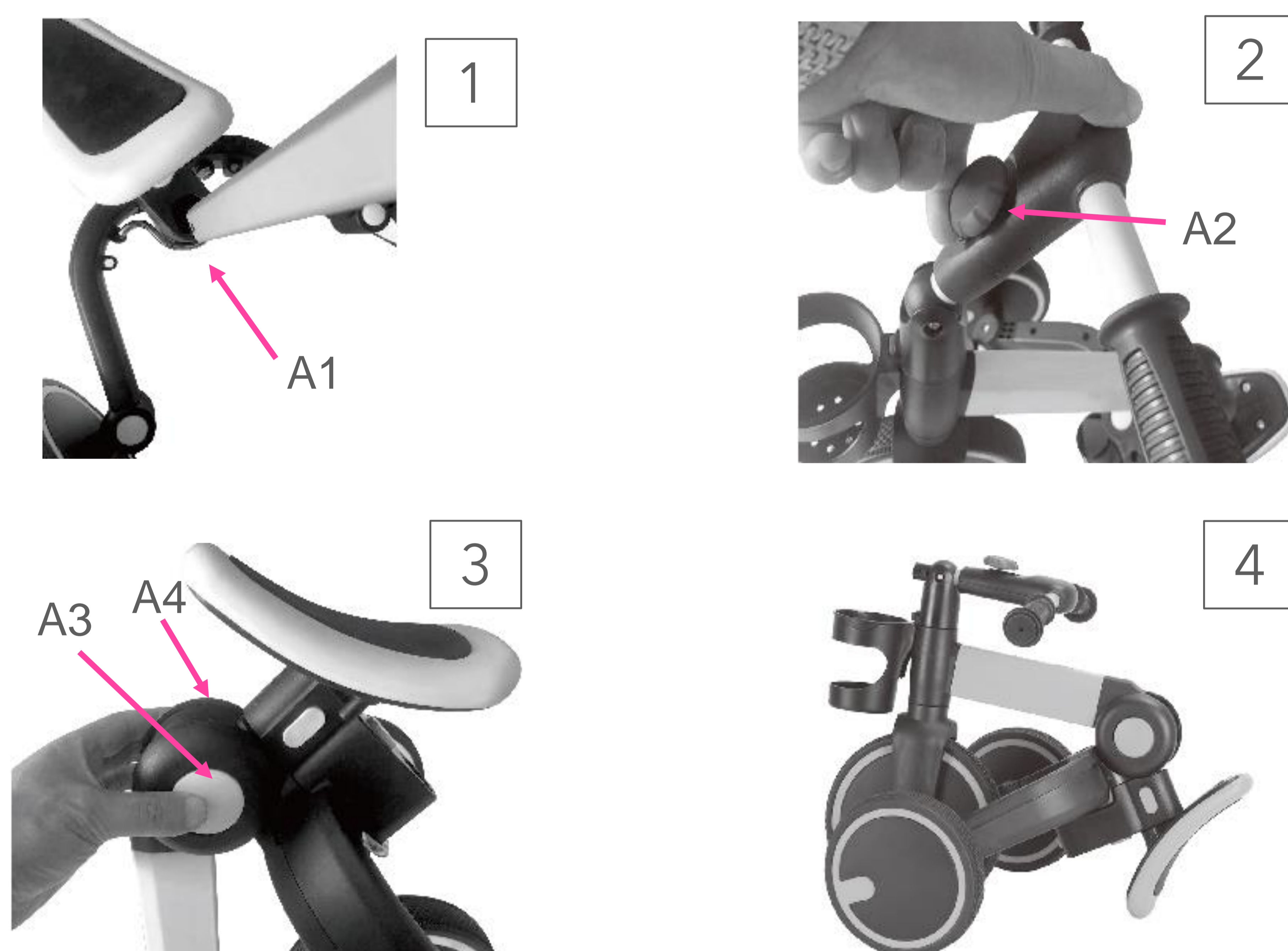

1. Press button A1,take out parent handle.
2. Push button A2 upwards and fold handlebar.
3. Press both sides of button A3 and A4 to fold main frame.
4. Folding mode is finished



4. Maintenance and care

- Security checks: check periodically the product to identify any loose or dislocated element particularly the wheels, pedals, seat and handlebars.
- Periodically check the tricycle and make sure that the frame and folding parts are in good condition.
- Periodic cleaning will bring a good life. Wipe the product with a damp cloth and dried with a dry cloth in order to prevent the formation of rust. Do not use detergents or bleaching agents.
- Regularly check the condition of abrasion and avulsion.
- Do not store the tricycle outside, prolonged exposure to the sun may cause fading and wear of the whole parts of the tricycle.
- When the tricycle is not in use, it must be stored in a dry and shaded place. Before storing, make sure that the tricycle is dry.
- Do not place heavy objects on top of the tricycle.
- Do not remove, disassemble or modify any part of the seat folding mechanism or the brakes.
- Do not store the tricycle near a direct source of heat and fire.
- You can apply oil on tricycle linking elements (e.g. frame, handlebar hinges).

5. Environmentally friendly disposal

Warning Danger of suffocation! Packaging material is dangerous for children. Never let children play with packaging material.

5.1 Disposal and packaging

The packaging of your unit consists of materials that are necessary to guarantee effective protection during transport. These materials are fully recyclable and therefore reduce the environmental impact. Dispose of the packaging in a bin for recyclable materials.

5.2 Disposal of old equipment

Old appliances must be disposed of in accordance with the guidelines and regulations of the local waste disposal authority. Check with your local administration for the address of the nearest recycling center and deliver your appliance there.



The symbol of the crossed-out dustbin on a Waste electrical or electronic equipment indicates that it must not be disposed of with household waste at the end of its life. Collection points for waste electrical and electronic equipment are available free of charge in your area. You can obtain the addresses from your city or local government. You can find out about other return options created by us on our website

www.fable-kids.com

The separate collection of Waste electrical or electronic equipment is intended to enable the reuse, recycling or other forms of recovery of Waste electrical or electronic equipment and to avoid the negative consequences of disposal on the environment and human health.



EU Declaration of Conformity

We

Canbolat Vertriebsgesellschaft mbH
Gneisenaustraße 10-11
97074 Würzburg
Germany

Declare, under our sole responsibility, that the product
Brand:

Fable Kids

Product Name: Kids Tricycle

Model Number: Emma

EAN: 4252023107181 / 4252023107198 / 4252023107204

to which this declaration relates, is in conformity with the
requirements of the Directives
2019/1922/EU
2009/48/EC

The Conformity was checked in accordance with the following
harmonised EN standards
EN 71-1: 2014+A1: 2018
EN 71-2: 2020
EN 71-3: 2019
EN 71-3:2019+A1:2021

Place and date of issue Würzburg, 01.08.2023

Signature:



Korhan Canbolat, Managing Director



FableKids

love inspired.



Office address:
Fablekids
Gneisenaustraße 10-11
D-97074 Würzburg

Return address can be found in the imprint: <https://www.fable-kids.com>

VAT identification number: DE 263752326
Court of the Commercial Register is Würzburg, HRB 10082
WEEE Reg.-No. DE 61617071



Office address: FableKids • Gneisenaustraße 10-11 •
97074 Würzburg



Our customer service number:
Tel. +44 (0) 208 068 5604



E-Mail: info@fable-kids.com



Return address can be found in the imprint: <https://www.fable-kids.com>