



NUASOL

The energy transition starts now!

Solar Panel Bracket



Type : 72cm / 105 cm / 118 cm

Model No.: NS-HE-AHT72/NS-HE-AHT105/NS-HE-AHT118





adjustable solar panel bracket

Table of contents

Foreword	5
1. Introduction	6
2. Safety instructions	7
3. Explanation of symbols	8
4. Scope of delivery	9
5. Assembly	10
6. Test steps after assembly	13
7. Maintenance	13
8. Tips for the correct screw fixation	14
9. Warranty and product information	15
10. Umweltschonende Entsorgung	17
EU - Declaration of Conformity	18





Thank you very much

that you have chosen our **NuaSol** product and are actively involved in the energy transition. According to our motto: "Together we can do the impossible", we want to offer everyone the opportunity to contribute sustainably to the preservation of our planet in an uncomplicated way.

We have set ourselves the goal of sharing the enthusiasm we have developed for renewable energies and especially for solar energy with everyone and making it accessible at fair prices. Be a part of the turnaround and get your environment to participate!

If you have any questions, please contact us via e-mail to info@nuasol.de or by phone at 0931 9080 3000.





1. Introduction

- The main material of this fastener is aluminum alloy AL6005-T5
- The product has a high corrosion resistance and the mounting kit allows quick assembly with stainless steel fasteners and precise placement of the holes
- Adjustable elevation angles
- Intended use: Flat surfaces
- Wide application: suitable for mounting on flat roofs, gardens and all other flat surfaces
- Adjustable degree: 0-90°
- Please read all instructions carefully before assembly











2. Safety

- When assembling, stay away from flammable objects.
- Note: all parts are surface treated to prevent damage during assembly and transport.
- When assembling, pay attention to the correct order, Position and steps to avoid damage.
- Parts or components should always be in good condition to prevent slipping and damage.
- In order to avoid personal injury, fitters must take safety precautions before and during assembly.
- Assembly work must be carried out in accordance with the instructions in order to avoid problems and accidents.
- Do not start assembly if the system is damaged or components are missing.
- During assembly and commissioning, fitters should pay attention to their own safety and falling objects to avoid injury or scratches.
- Ice, snow and dew on the surface of the components should be removed before assembly. Note: The coating of the component must not be damaged.
- Clean the friction surface of the screws before installation. Make sure there is no dirt such as water droplets, mud or oil.



3. Explanation of symbols

	<p>Danger This sign indicates a hazard that could lead to the destruction of the system or death or serious injury.</p>
	<p>Falling components This symbol indicates the possibility of falling parts and the resulting danger to third parties or property.</p>
	<p>Danger when lifting When lifting or roping components, there is a risk of improperly attached parts or loose ropes. The area below must be kept clear. Parts can get out of control due to the wind.</p>
	<p>Read the instruction manual in its entirety before starting assembly.</p>
	<p>Wear goggles when drilling, sawing, bending.</p>
	<p>Wear a seat belt when you are on unsafe terrain.</p>
	<p>Wear hearing protection when drilling, sawing, bending.</p>
	<p>Wear work gloves. Metal burrs may be present.</p>



4. Scope of delivery

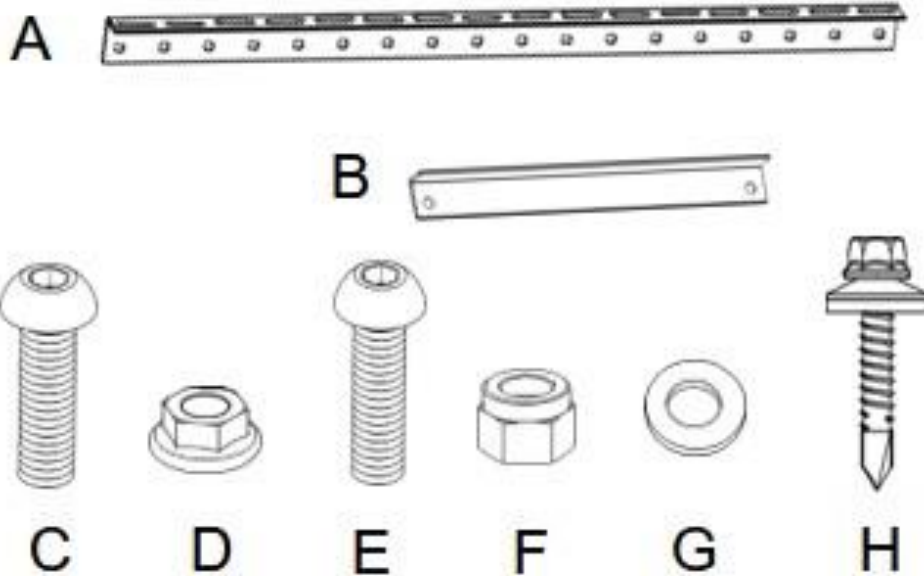

EAN		4252023111485		4252023111492		4252023111508	
Partno.	Designation	Size	Quantity	Size	Quantity	Size	Quantity
A	Aluminium Stange, long	720mm	4X	1050mm	4X	1180mm	4X
B	Aluminum rod, short	305mm	2X	365mm	2X	525mm	2X
C	Inbusschraube	M8X20	6X	M8X20	6X	M8X20	6X
D	Mother	M8	6X	M8	6X	M8	6X
And	Inbusschraube	M6X20	4X	M8X20	4X	M8X20	4X
F	Union nut	M6	4X	M8	4X	M8	4X
G	Washer	M6	4X	M8	4X	M8	4X
H	Self-drilling screws	6.0X38	6X	6.0X38	6X	6.0X38	6X



5. Assembly

Open the package and carefully remove the packaging material.

Step 1: Take out the pre-assembled triangle bracket, set the desired angle.

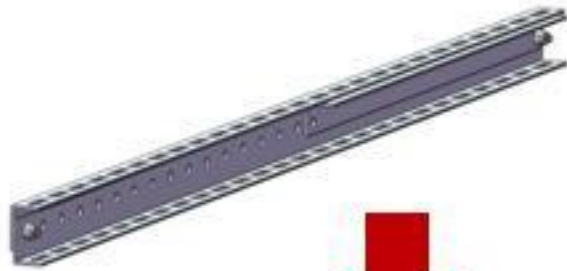

Step 2: Tighten the M8x20 screw.

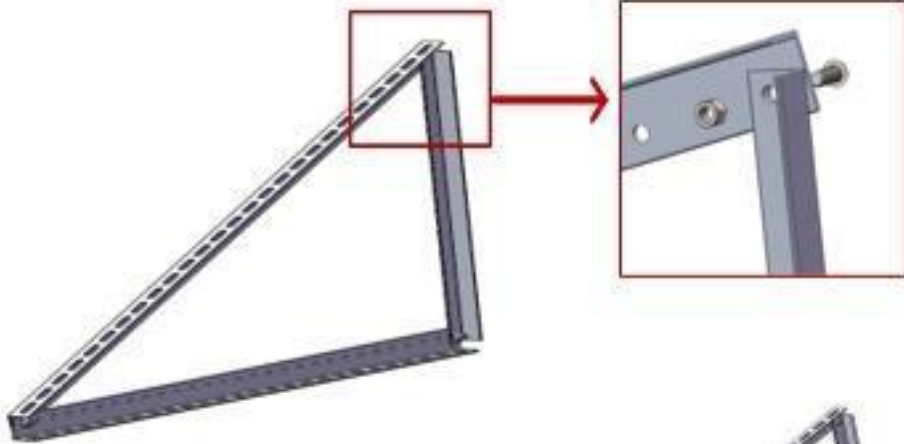

Step 3: Repeat step 1 - 2 to set up the second bracket.





Step 4: Mount the bracket on the panel with screws M8X20 / M6x20.

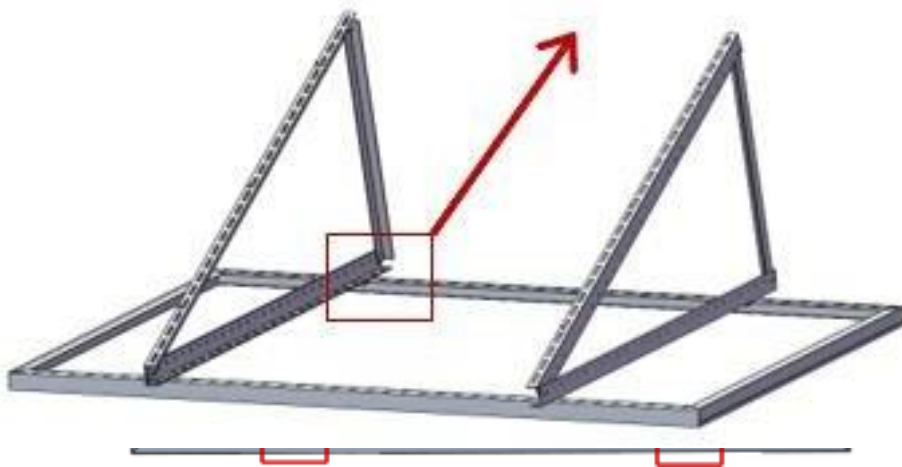

Info:

- Verwenden Sie für das Modell 720 mm den Bolzentyp M6x20
- Verwenden Sie für das Modell 1050mm / 1180mm den Bolzentyp M8x20

Inbusschraube

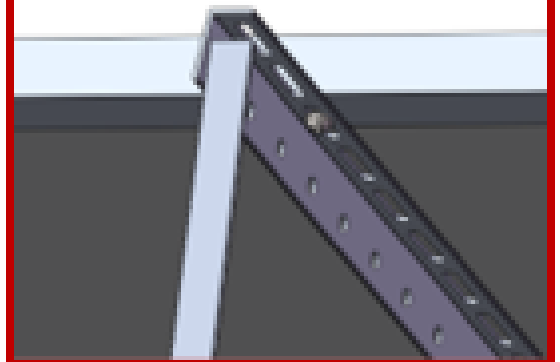



For a stable hold, you can use the bracket with the self-drilling screw 6.0x38 fasten.



The assembly is complete.



6. Test step after assembly

It is necessary to check the condition of all components and parts after the assembly is completed.

Please check:

- the system for damage
 - tight fit of the screws
 - whether all BK modules are mounted accordingly
- Please clean the module after installation.

Small parts that are left over, such as screws, conductive plates, etc., should be checked again according to the instructions to ensure that all required mounting parts have been used.

Warning: Make sure that the assembly is complete according to the instructions before connecting the module.

7. Maintenance

- Please check all bolt connections once a year. Tighten when the connection comes loose.
- Once a year, check all mechanical components for fit and possible visual changes.
- Clean the glass surface of the BK modules with distilled water if dirty. For example: in the spring after the pollen count or after rain.

ATTENTION: Optical abnormalities or scratches on the component hooks, center/end terminals or the mounting rail, due to manufacturing, are not defects and are not recognized as such. Possible abnormalities in the surface finish do not affect the safety or functionality of the overall system.



8. Tips for proper screw fixation

NOTE: These instructions are only intended to explain the correct attachment of the bracket, not the actual solar panel.

Precautions when assembling stainless steel fasteners

Stainless steel has good ductility and is different from carbon steel. Improper use will result in the fact that the screws and nuts cannot be loosened afterwards.

In order to prevent the blocked screws, please proceed as follows:

- **reduce possible friction of the parts**
- **make** sure that the thread surface is clean (for example, no ash, debris);
- it is recommended to coat the surface of the screws with water wax or use lubricants (such as butter, engine oil) during assembly.

Correct execution:

- **it** must be screwed perpendicular to the threaded axis. Do not tilt.
- during the tightening process, the force must be uniform, and the tightening torque should not exceed the specified safe torque value.
- it is recommended to use a torque wrench or socket wrench. Avoid using an adjustable wrench or an electric screwdriver. If you need to use an electric screwdriver, you should try to reduce the speed.
- do not mount at high temperatures, do not use fast rotation, avoid a rapid rise in temperature



9. WARRANTY AND PRODUCT INFORMATION

What does this warranty cover and how long is it valid?

This limited warranty is provided by the **NuaSol** brand of **Canbolat Holding** and covers manufacturing and material defects in your product. To claim warranties, you must provide proof of purchase.

This limited warranty is transferable to subsequent owners, but only for the remainder of the warranty period. Subsequent owners must also provide the original proof of purchase, as described in "What kind of proof of purchase is required?".

What services does **NuaSol** offer?

During the warranty period, NuaSol will, at its option, repair the product (if commercially feasible) or replace the defective product at no cost, provided that you have **reported the product defect to NuaSol within the warranty period, and provided that** NuaSol confirms the existence of such a defect by means of inspection and that defect is covered by this Limited Warranty.

NuaSol will, at its sole discretion, use new and/or refurbished parts for warranted repairs and the construction of replacement products. **NuaSol** reserves the right to use parts or products in the original or improved design for repair or replacement. After **NuaSol** has repaired or replaced a product, the original warranty period will continue to be valid for the remainder of the warranty period or for 90 days from the date of return to the customer, whichever is longer. All replaced products and all parts removed from the repaired products become the property of **NuaSol**.

How do you get services?

If your product requires a fault or a guaranteed service, contact your dealer. If you are unable to contact your dealer or if the dealer is unable to provide the service, please contact **NuaSol** directly at:

NuaSol by Canbolat Holding

E-Mail: info@nuasol.de

Tel: 0931 9080 3000

What is not covered by this warranty?

Claims are limited to repair or replacement, or, if this is not possible at **NuaSol's** discretion, compensation will be limited to a maximum of the purchase price paid for the product. **NuaSol** will only be liable to you for any direct damage you have suffered and only up to a maximum amount equal to the purchase price of the product.

This limited warranty is not a guarantee of uninterrupted or error-free operation of the product or does not cover normal wear and tear of the product or costs associated with the removal, installation or troubleshooting of the customer's electrical equipment. This warranty does not apply to the following defects or damages, for which NEP assumes no responsibility:



- a) on the product if it has been misused, neglected, improperly installed, materially damaged or modified internally or externally, or it has been damaged due to improper use in an unsuitable environment;
- b) on the product if it has been exposed to fire, water, general corrosion, biological contamination or an input voltage resulting in operating conditions beyond the maximum or minimum limits specified in the **NuaSol** product specifications, including a high input voltage generated by generators and lightning strikes;
- c) on the product, if it has not been approved by **NuaSol** or its authorized service centers (hereinafter referred to as "ASCs") has been repaired;
- d) on the product, if it is used as a component of a product whose warranty is expressly provided by another manufacturer;
- e) on the product, if the original markings for its identification (trademark, serial number) have been defaced, modified or removed;
- f) on the product if it is used outside the country in which it was purchased; and
- g) any consequential damage resulting from a loss of performance of the product, whether caused by a malfunction of the product, incorrect installation or incorrect use.

Product Disclaimer

THIS LIMITED WARRANTY IS THE SOLE AND EXCLUSIVE WARRANTY PROVIDED BY NUASOL IN CONNECTION WITH YOUR **NUASOL** PRODUCT AND, TO THE **FULLEST EXTENT PERMITTED BY LAW, SUPERSEDES ALL OTHER WARRANTIES, CONDITIONS, REPRESENTATIONS, REPRESENTATIONS, OBLIGATIONS AND LIABILITIES, WHETHER EXPRESS OR IMPLIED, STATUTORY OR OTHERWISE, ARISING OUT OF OR IN CONNECTION WITH** THE PRODUCT (WHETHER MADE AS OF CONTRACT, WRONG, NEGLIGENCE, PRINCIPLES OF MANUFACTURER'S LIABILITY, BY OPERATION OF LAW, COURSE OF ACTION, OPINION OR OTHERWISE), INCLUDING WITHOUT LIMITATION ANY IMPLIED WARRANTY OR CONDITION OF QUALITY, MERCHANTABILITY OR FITNESS FOR A PARTICULAR PURPOSE. ANY WARRANTY OF MERCHANTABILITY OR FITNESS FOR A PARTICULAR PURPOSE TO THE EXTENT REQUIRED FOR THE PRODUCT UNDER APPLICABLE LAW IS LIMITED TO THE PERIOD SET FORTH IN THIS LIMITED WARRANTY.

IN NO EVENT SHALL **NUASOL** BE LIABLE FOR: (A) ANY SPECIAL, INDIRECT, INCIDENTAL OR CONSEQUENTIAL DAMAGES, INCLUDING LOST PROFITS, LOSS OF REVENUE, LOSS OF SAVINGS OR OTHER COMMERCIAL OR ECONOMIC LOSS OF ANY KIND, EVEN IF NEP HAS BEEN ADVISED OF OR SHOULD HAVE KNOWN OF THE LIKELIHOOD OF SUCH DAMAGES, (B) ANY LIABILITY ARISING FROM TORTIOUS ACTION, WHETHER DUE TO NEGLIGENCE ON THE PART OF NEP, AS WELL AS FOR ANY LOSS OR DAMAGE TO PROPERTY, OR FOR PERSONAL INJURY OR ECONOMIC LOSS OR DAMAGE CAUSED BY THE CONNECTION OF A PRODUCT TO ANOTHER DEVICE OR SYSTEM, AND (C) ANY DAMAGE OR INJURY CAUSED BY OR RESULTING FROM INCORRECT OR IMPROPER USE, OR RESULTING FROM INCORRECT INSTALLATION, INCORPORATION OR COMMISSIONING OF THE PRODUCT.

IF YOU ARE A CONSUMER (RATHER THAN A PURCHASER OF THE PRODUCT IN THE CONTEXT OF A BUSINESS TRANSACTION) AND HAVE PURCHASED THE PRODUCT IN A MEMBER COUNTRY OF THE EUROPEAN UNION, THIS LIMITED WARRANTY IS SUBJECT TO YOUR RIGHTS AS A CONSUMER UNDER EU DIRECTIVE 1999/44/EC ON CERTAIN ASPECTS OF THE SALE OF CONSUMER GOODS AND GUARANTEES IN ACCORDANCE WITH THE IMPLEMENTATION OF THIS DIRECTIVE IN THE EU MEMBER STATE, IN WHICH YOU PURCHASED THE PRODUCT. ALTHOUGH THIS LIMITED WARRANTY GIVES YOU CERTAIN LEGAL RIGHTS, YOU MAY HAVE OTHER LEGAL RIGHTS THAT MAY VARY BY EU MEMBER STATE, OR IF YOU DID NOT PURCHASE THE PRODUCT IN AN EU MEMBER STATE, YOU MAY HAVE RIGHTS DEPENDING ON THE COUNTRY AND JURISDICTION OF THE COUNTRY IN WHICH YOU PURCHASED THE PRODUCT.



10. Environmentally friendly disposal

Warning: Choking hazard! Packaging material is dangerous for children. Never let children play with packaging material.

15.1 Disposal and packaging

- The packaging of your device is made of materials that are necessary to guarantee effective protection during transport. These materials are fully recyclable, thus reducing the environmental impact. Dispose of the packaging in a bin for recyclable materials.

15.2 Disposal of old equipment

- Old appliances must be disposed of in accordance with the directives and the regulations of local waste disposal. Contact your local administration about the address of the nearest recycling center and deliver your device there.



The symbol of the crossed-out dustbin on an old electrical or electronic device means that it must not be disposed of with household waste at the end of its service life. Collection points for waste electrical and electronic equipment are available in your area for free return. You can obtain the addresses from your city or local government. You can www.nuasol.com find out about other return options created by us on our website.

 The separate collection of waste electrical and electronic equipment is intended to facilitate the reuse, recycling or other forms of waste electrical and electronic equipment. recycling of old appliances, as well as avoiding the negative consequences of disposal on the environment and human health.

Note on battery disposal

The symbol of the crossed-out dustbin on batteries or accumulators indicates that they must not be disposed of with household waste at the end of their service life. If batteries or accumulators contain mercury (Hg), cadmium (Cd) or lead (Pb), you will find the respective chemical symbol below the symbol of the crossed-out trash can. You are legally obliged to return old batteries and accumulators after use. You can do this free of charge at the retail store or at another collection point near you. Addresses of suitable collection points can be obtained from your city or local government.

Our customer service number: Tel. +49 (0) 931 9080 3000

Fax: +49 (0) 931 4523 2799 / E-Mail: info@nuasol.com

NuaSol by Canbolat Vertriebs GmbH • Gneisenaustraße 10-11 • 97074 Würzburg Return

address can be found in the imprint: <https://www.nuasol.com/impressum>

Sales tax identification number: DE 263752326

The court of entry in the commercial register is Würzburg, HRB

10082 WEEE-Reg.-Nr. DE 61617071

