

AREBOS

Robotic Pool Cleaner

AR-HE-PRAPP



Please follow all security measures in this user's manual to ensure a secure use.



Thank you for trusting in AREBOS.

Table of Contents

1 Introduction and safety instructions.....	3
2 Scope of delivery	8
3 App Control.....	8
4 Operating the Robotic Pool Cleaner.....	9
5 Maintenance and storage	13
6 Troubleshooting	14
7 Technical Data	15
8 Environmentally friendly disposal.....	16
EU Declaration of Conformity	17

Thank you for purchasing our product. Please read the operating instructions carefully before using the product for the first time. If you give the product to a third party, this manual must be handed over with it. Keep the instruction manual for future reference. The drawings in this manual may not match the physical objects. Please refer to the physical objects.

1 Introduction and safety instructions

Introduction

- This instruction handbook is intended to familiarise you with the installation, use and maintenance of the product. To install the unit safely and correctly, please read the operating instructions **before** you start.

Explanation of the symbols



Warning! Read the safety instructions carefully. Failure to follow the safety precautions could result in serious injury or damage. Keep the operating instructions in a safe place.



Note! Pull out the mains plug.



Warning! Risk of electrical voltage!



Use with caution when using this article!

 **WARNING!** This signal symbol/word indicates a hazard with a medium level of risk which, if not avoided, may result in death or serious injury. injury if not avoided.

 **CAUTION!** This signal symbol/word indicates a hazard with a low level of risk which, which, if not avoided, may result in a minor or moderate injury. injury if not avoided.

Note! This signal symbol/word warns you of possible property damage.



This product **must not** be disposed of with household waste!





By means of a CE marking, it can be recognized that a product complies with the legal requirements of European legal standards and therefore may be traded within the European Community.



Dear Owner: Thank you for choosing robotic pool cleaner. In order to achieve optimal performance, please read and follow these steps:

1. Cleaner filter bags should be thoroughly cleaned after each use or as often as needed to ensure cleaner's optimal performance.
2. Before using your cleaner and especially when opening the pool for the first time remove larger items from the pool that may diminish the cleaner's performance. Clean filter bags frequently when pool is excessively dirty.
3. Cleaner may stop in the middle of the pool and reverse during cleaning cycle. This is a normal part of the programmed cycle.
4. DO NOT start cleaner out of the water. Power button should only be switched to "I" position when unit is submerged. The unit will automatically shut off, but it is best to put power switch in "O" position when unit completes cleaning.
5. The electric supply connection shall be made by a qualified electrician and comply with IEC 60364-1. It is recommended that the electric supply to this machine should include either a residual current device that will interrupt the supply if the leakage current to earth exceeds 30 mA for 30 ms or a device that will prove the earth circuit.
6. The power supply box (including safety isolated transformer) of swimming pool cleaner must be located at minimum 3.5 meters away from the pool edge and minimum 2.5 meters overtop of top edge of pool (outside Zone 1 defined in IEC 60364-7-702).
7. The length of the supply cord of power supply box is maximum 0.5 meters.

 **CAUTION!**





1. This appliance can be used by children aged from 8 years and above and persons with reduced physical, sensory or mental capabilities or lack of experience and knowledge if they have been given supervision or instruction concerning use of the appliance in a safe way and understand the hazards involved. Children shall not play with the appliance. Cleaning and user maintenance shall not be made by children without supervision.
2. If the supply cord is damaged, it must be replaced by the manufacturer, its service agent or similarly qualified persons in order to avoid a hazard.
3. The pump must be supplied through a residual current device (RCD) having a rated residual operating current not exceeding 30 mA.
4. Do not operate the cleaner when people are in the pool.
5.  **CAUTION!** The control box of the appliance must be fixed to the ground or the wall securely! Never operate the unit without fixing the control box first!
6.  **CAUTION!** The control box must be fixed at a minimum distance of 3.5m from the edge of the swimming pool!"
7.  **CAUTION!** The appliance is only to be used with the power unit provided with the appliance.

Important safety precautions

- Your safety is of the most importance to us. Please make sure that you read this instruction booklet **before** attempting to install and use the appliance. If you are unsure of any of the information contained in this booklet, please contact the Retailer where you purchased your unit.
-  **WARNING!** Read all safety and usage instructions. Failure to follow the safety information and instructions can cause electric shock, fire and/or serious injury. Keep all safety and usage instructions for future reference.
- **DO NOT** use the product until you read the instruction manual.
- Make sure you have read the instruction manual thoroughly and understand the contents before you start the installation.
- The instructions are in the interest of your safety.
-  **WARNING! Danger of suffocation!** Packaging material is dangerous for children. Never let children play with packaging material.

Attention User: This manual contains important information that will help you in operating and maintaining this pool cleaner. Please retain it for reference.

 **WARNING!** Before installing this product, read and follow all warning notices and instructions which are included. Failure to follow safety warnings and instructions can result in severe injury, death, or property damage. Consumer Information and Safety service after installed, operated and maintained according to the information in this manual. Be sure to read and comply with all of the warnings and cautions.

 DANGER!	Risk of electrical shock or electrocution The electrical supply to this product must be installed in accordance with all applicable local codes and ordinances. Improper installation will create an electrical hazard which could result in death or serious injury to pool users or others due to electrical shock and may also cause damage to property.
 WARNING!	Do not play with cleaner or cable or apply to body. Can trap or tear hair or body parts. Cable can trip or entangle swimmers which could result in drowning.
 WARNING!	The control box of appliance must be fixed securely on the ground wall. Never operate the unit without fixing.
 WARNING!	To reduce the risk of injury, do not let children use or play with pool cleaner.
 CAUTION!	Before installing the cleaner, understand cleaner coverage. The cleaner was not designed to automatically clean steps or to work under a solar cover. It was also not designed to do initial clean-up for a new pool installation.

Important safety instructions

IMPORTANT SAFETY INSTRUCTIONS

The CLEANER automatic swimming pool vacuum cleaner has been manufactured with the highest degree of care and concern for safety. We suggest the following safety precautions become part of your pool safety regulations:

SAVE THESE INSTRUCTIONS

1. ALWAYS PUT THE MACHINE INTO THE WATER BEFORE CONNECTING IT TO THE ELECTRICAL OUTLET.
2. IT IS IMPORTANT FOR SWIMMERS' SAFETY TO REMOVE THE UNIT IMMEDIATELY FOLLOWING USE. THIS CAN ALSO IMPROVE THE OPERATING LIFE OF YOUR CLEANER.
3. BE CERTAIN THE MACHINE IS ONLY PLUGGED INTO A GROUNDED ELECTRICAL OUTLET EQUIPPED WITH AN APPROVED AND PROPERLY OPERATING GROUND FAULT CIRCUIT INTERRUPTER (GFCI).
4. DO NOT HANDLE MACHINE WHILE IT IS PLUGGED INTO THE ELECTRICAL OUTLET.
5. DO NOT USE AN EXTENSION CORD. THIS COULD CREATE A SAFETY HAZARD AND/OR DAMAGE YOUR CLEANER.
6. **ALWAYS STAY OUT OF THE POOL WHILE CLEANER IS IN OPERATION.**
7. NEVER ALLOW PLUG TO ENTER THE POOL.
8. DO NOT OPERATE THE MACHINE OUT OF WATER. THIS WILL DAMAGE THE MOTOR SEAL AND VOID THE WARRANTY.
9. DO NOT DRAG THE MACHINE OUT OF THE POOL AGAINST THE SIDE WALL. THIS COULD DAMAGE UNIT AND/OR YOUR POOL WALL.
10. DO NOT BURY CORD. REPLACE DAMAGED CORDS.
11. WARNING- TO REDUCE THE RISK OF INJURY, DO NOT PERMIT CHILDREN TO USE THIS PRODUCT UNLESS THEY ARE CLOSELY SUPERVISED AT ALL TIMES.
12. IF THE SUPPLY CORD IS DAMAGED, IT MUST BE REPLACED BY THE MANUFACTURER, ITS SERVICE AGENT OR SIMILARLY QUALIFIED PERSONS IN ORDER TO AVOID A HAZARD.

While the CLEANER has been made to operate as safely as possible, we suggest you exercise reasonable care in the handling of the vacuum and inspect the electrical cord frequently for damage or wear, as with any other electrical appliance. After use, remove the unit and rinse with fresh water and remove any twists that may be present in the cord.

PREVENTATIVE MAINTENANCE

In order to maximize efficiency and receive long term service of your unit, we suggest the following:

- Thoroughly rinse entire unit after use.
- Clean filter bags thoroughly after each use—a clogged filter can decrease efficiency dramatically.
- Remove any twists in the cord after each use. Twisting should be minimal if the unit is functioning properly. Laying cord, straightened out in sunlight is helpful.
- Avoid allowing the unit to “cool down” in the water.
- Inspect filter bags frequently. Replace when necessary.

Further warnings and cautions

 **WARNING!** Your cleaner should not be used while people are swimming in the pool. Do not allow swimmers in the pool while pool cleaner is operating.

 **WARNING!** Keep cleaner away from child or use under adult's strict and close supervision.

 **WARNING!** DO NOT switch ON the pool cleaner if it is not immersed in the water. Operating the cleaner out of the water may cause severe damage and will result in loss of warranty.

 **WARNING!** Always remember to turn the power supply OFF and unplug it from the power outlet before removing the cleaner from the pool.

 **WARNING!** DO NOT PULL THE POOL CLEANER FROM THE POOL USING THE CABLE.

 **WARNING!** To use this cleaner only when water temperature is 10-35°C and depth of the pool is 0.5m-3m. The cleaner is designed to work for the pool with 100m² surface area.

 **WARNING!** Keep the controller box in a dry place which is 3.5m away from the pool.

Product introduction

The cleaning robot is a kind of the underwater cleaner, it is fully automatically. It is mainly used to clean the dirt and debris such as hair, leaves and sand from the pool floor, pool wall and waterline. As long as you put it into the pool after initial program setting, the cleaning robot can automatically measure the size of the pool, automatically design the working route and clean the pool by itself.

2 Scope of delivery

Parts breakdown and replaceable Parts List

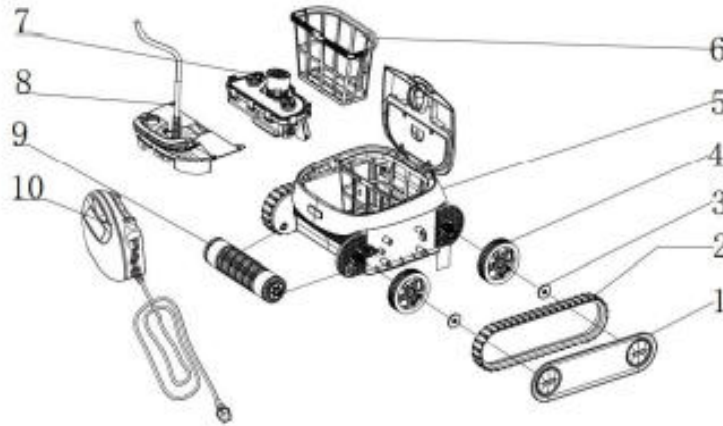

1.	Guard plate (left&right)
2.	Driver belt
3.	Drive wheel fixing block
4.	Gear wheel group
5.	Base components
6.	Filter basket
7.	Motor box
8.	Floatable wire assembly
9.	Front-wheel-brush components
10.	Control box components

3 App Control

You can easily operate the pool robot via an app.

You can download the app for free from Google Play or the App Store. To do this, enter "Cipu" in the search bar and install the app.



Bluetooth connection:

1. Press Connect
2. In the next step, select the pool robot in the device list

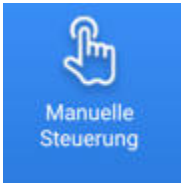

Aktivieren Sie die Bluetooth-Verbindung um fortzufahren.

Gerät verbinden

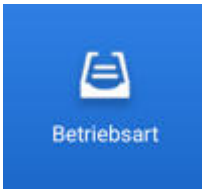
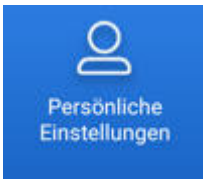
You have the following settings:

<p>Manual control</p>  <p>Manuelle Steuerung</p>	<p>Steer the robot in the desired direction or pause</p> 
<p>Set the desired operating mode</p>  <p>Betriebsart</p>	<p>1. Bodenreinigung to clean only the pool floor and to increase cleaning efficiency.</p> <p>2. All-purpose cleaning Full cleaning, including pool floor; Pool wall and waterline.</p> <p>3. Waterline for quick cleaning of the waterline.</p>
<p>Personal settings</p>  <p>Persönliche Einstellungen</p>	<p>Here you can make custom settings</p>

4 Operating the Robotic Pool Cleaner

 WARNING!	<p>Your cleaner should not be used while people are swimming in the pool.</p>
 WARNING!	<p>The electric supply connection shall be made by a qualified electrician and comply with IEC 60364-1. It is recommended that the electric supply to this machine should include either a residual current device that will interrupt the supply if the leakage current to earth exceeds 30 mA for 30 ms or a device that will prove the earth circuit.</p>

 WARNING!	Do not allow swimmers in the pool while pool cleaner is operating. DO NOT switch on the pool cleaner if it is not immersed in the water. Operating the cleaner out of the water may cause severe damage and will result in loss of warranty. Always remember to turn the power supply “O” and unplug it from the power outlet before removing the cleaner from the pool.
---	--

GENERAL INFORMATION

Congratulations! You have got the most advanced automatic swimming pool cleaner. The robot is easy to use and will help you cleaning your swimming pool. Operated according to this manual, your robot will clean your pool quickly and effectively.

PLEASE READ AND FOLLOW ALL INSTRUCTIONS CAREFULLY BEFORE PUTTING YOUR CLEANER INTO USE.

Deterioration, discoloration or brittleness of any pool finish can be caused over time separately by, or in combination with, age, incorrect pool water chemistry, improper installation, and other factors. Customer hereby disclaims any and all claims, and releases Manufacturer from any and all claims for damages to any pool plaster or vinyl liner in Customer’s pool by reason of the use and/or operation of the Cleaner. Under no circumstances shall the Manufacturer be liable for any loss or damage, whether direct, consequential or incidental, arising out of the use or inability to use the cleaner in customer’s pool.

FEATURES

- The swimming pool cleaner is independently scrubs, vacuums, and filters your pool.
- No installation, no attachments. Just drop it in and turn it on. It is completely automatic.
- Electronic Self-Diagnostics and overload Protection.
- It can be serviced in all shapes of pools.

GENERAL OPERATING INSTRUCTIONS

Remove the CLEANER by placing the carton down and removing it from the box as shown. If the Caddy Cart is included, the CLEANER and the Power Supply will be premounted to the cart.

Operation instructions

Brief introduction

1. Start/Stop
 Could measure the pool size automatically and set the working cycle.
2. Mode of floor clean only
 To only clean the pool floor to increase the clean efficiency
3. Mode of all purpose clean
 All-around cleaning, including pool floor; pool wall and waterline.
4. Mode of waterline clean only

To quick clean waterline only.

5. Use App to control (not available for all models)

To control the cleaner by Bluetooth and clean the pool.

Operation instructions

1. Connect floating power cord.

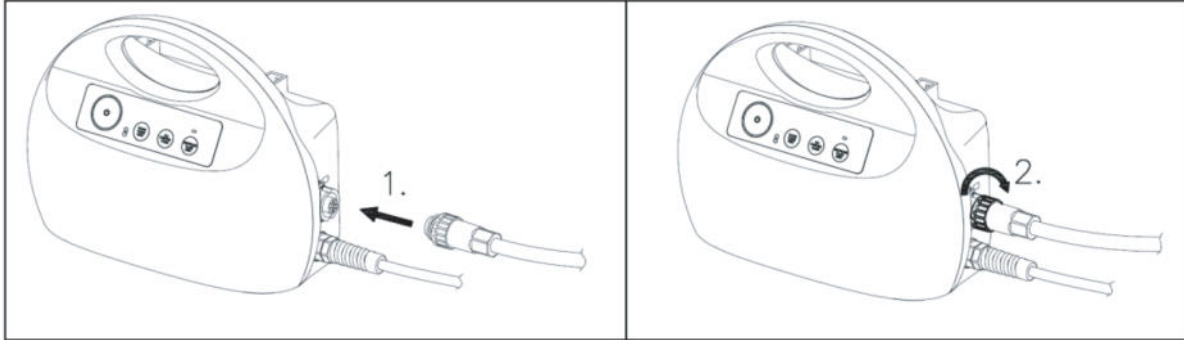

2. Position the power supply so that it is approximately in the middle of the long side of the pool at a distance of 3.5m /11.5ft. Fixation in the middle of longer side is recommended, if you have a rectangle or oval shape pool.

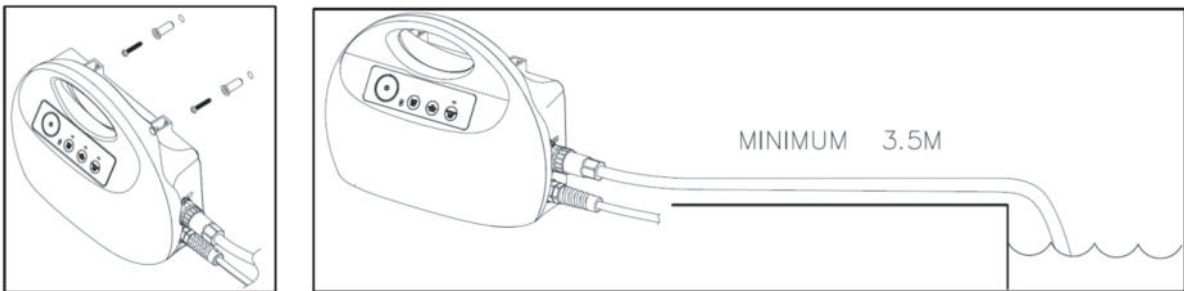

3. Put the Pool Cleaner into the pool. Release the Pool Cleaner and let it sink to the floor of the pool. Make sure that the floating cable is free of any obstructions.
4. Turn the power supply ON (230V AC 50HZ) in the position of I. One of the three modes light will be on. Press the button for the mode you want to run, then press ON/OFF button, the Pool Cleaner will now operate until it has reached the end of the cleaning cycle.
5. Mode switching: Press ON/OFF button, choose the mode, press ON/OFF button to start the cleaner.

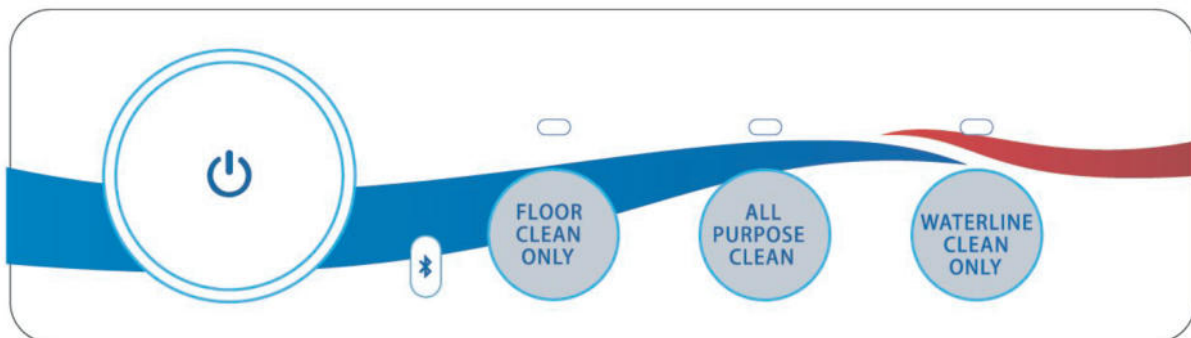

6. Indicator lights %

LED Light	Status	Indication
White	ON	Normal operation of the pool cleaner
White	Blinking twice	Work reversely after meeting obstacles
White	Always blinking	Bluetooth communication with the pool cleaner or standby status
Red	ON	Overload or no-load protection Let the cleaner sink to the floor of the pool, and Press ON/OFF to start again.

 **CAUTION!** When pulling the cable, reel it in hand-over-hand, **DO NOT** reel it around your arm. The floating cable should be straight before and after work.

DO NOT ENTER THE SWIMMING POOL WHEN THE CLEANER IS OPERATING

The operating water temperature range for the CLEANER is 10°C - 35°C.

The operating depth of CLEANER is minimum 0,5m , maximum 3m.

Remove the CLEANER from the pool after each use. Keeping the CLEANER permanently in the pool may result in additional service requirements.

5 Maintenance and storage

Routine Maintenance

1. Clean the filter basket

Turn off the Pool cleaner. Open the filter cover. Clean the filter basket with a hose. Insert the clean filter basket and close the filter cover.

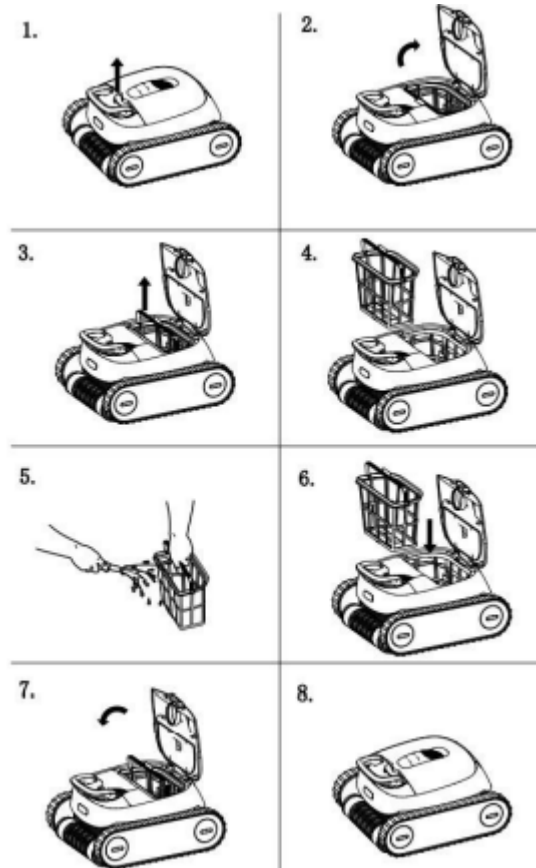

Make sure the power supply is switched off and unplugged.

It is highly recommended to clean the filter basket after each cleaning cycle.

⚠ WARNING! Disconnect the power supply from electrical outlet before cleaning moving parts.

2. Routine Maintenance of the floating cable

The floating cable may get twisted after 8 hours of continuous work, please untwist the cable then before re-start the pool cleaner. After each use, roll up the cable so that it has no kinks.

Storage

When out of the water, store the CLEANER in a dry, shady location at temperatures between 4°C and 46°C.

Cable Care

With continued use, the cable may become coiled (like a telephone cord). To correct this, periodically stretching the cord out in the sun should remove any cord twists.

IMPORTANT: The cable should be checked periodically for any external damage.

Important Tips

- Cleaning the filter bags after every use maximizes the unit’s performance.
- Replace worn brushes.
- In a pool with usually high calcium content, more frequent cleaning of the filter is recommended.
- Save the CLEANER original carton for extended storage or shipping requirements when CLEANER require dealer service.
- **The sealed Motor Unit and the Power Supply contain no user-serviceable parts.**
- **Opening them will automatically VOID your warranty.**
- Remove items such as thermometer, toys and the like from the pool before operating the unit. Such items can jam the cleaner and cause damage to the unit and/or your pool.

6 Troubleshooting

Symptom	Possible reason	Corrective action
The pool cleaner moves but does not clean the pool	Clogged filter basket	Clean the filter basket
The pool cleaner does not move	An obstacle blocks the impeller An obstacle blocks the drive belt	Unplug the power supply. Open the impeller cover and check that nothing is trapped in the impeller. Verify that nothing blocks the tracks or wheels.
Debris out from the outlet	Filter basket is broken	Replace the filter basket
	Filter basket is full	Clean the filter basket
The floating cable has kinks	Working for too long time, over 8 hours	Untwist the floating cable before re-start.
Stop working	Overload or no-load protection	Let the cleaner sink to the floor of the pool, and press ON/OFF to start again.

7 Technical Data

Specifications	
Product Model	AR-HE-PRAPP
Article Number	4260627428526
Product dimension	470 x 410 x 255 mm
Package dimension	695 x 470 x 400 mm
Product weight	Around 13.4 KG
Package weight	Around 17.3 KG
Cleaning area	All-around
Filtration accuracy	≥160µm
Length of floating cable	17m
Filter speed	14-18 m ³ /h
Output voltage	24V DC
Output current	4.5A
Input voltage	230V
Frequency	50Hz
Horsepower	150W
IP Class for controller box	IP54
IP Class for motor	IPx8

We reserve the right to make technical and optical changes to the article in the course of product improvements.

8 Environmentally friendly disposal

 **WARNING! Danger of suffocation!** Packaging material is dangerous for children. Never let children play with packaging material.

Disposal and packaging

- The packaging of your unit consists of materials that are necessary to guarantee effective protection during transport. These materials are fully recyclable and therefore reduce the environmental impact. Dispose of the packaging in a bin for recyclable materials.

Disposal of old equipment

- Old appliances must be disposed of in accordance with the guidelines and regulations of the local waste disposal authority. Check with your local administration for the address of the nearest recycling centre and deliver your appliance there.



The symbol of the crossed-out dustbin on a Waste electrical or electronic equipment indicates that it must not be disposed of with household waste at the end of its life. Collection points for waste electrical and electronic equipment are available free of charge in your area. You can obtain the addresses from your city or local government. You can find out about other return options created by us on our website www.arebos.de.



The separate collection of Waste electrical or electronic equipment is intended to enable the reuse, recycling or other forms of recovery of Waste electrical or electronic equipment and to avoid the negative consequences of disposal on the environment and human health.

Our customer service number: Tel. +44 (0) 208 068 5604

Fax: +49 (0) 931 4523 2799 / E-Mail: info@arebos.de

Office address: Canbolat Vertriebs GmbH • Gneisenastraße 10-11 • 97074 Würzburg

Return address can be found in the imprint: <https://www.arebos.de/impressum/>

Sales tax identification number: DE 263752326

Registration court in the commercial register is Würzburg, HRB 10082

WEEE-Reg. No. DE 61617071

EU Declaration of Conformity



We, the

Canbolat Vertriebsgesellschaft mbH
Gneisenaustraße 10-11
97074 Würzburg
Germany

declare in sole responsibility that the following product:

Brand

AREBOS

Product Name

Robotic Pool Cleaner

Product Model
Article Number

AR-HE-PRAPP
4260627428526

has been developed, constructed
and manufactured in compliance
with the requirements of the
European Directives:

2014/35/EU

The object of the declaration described above is in conformity with the relevant European Union harmonization legislation.

The assessment is based on the
following applied **harmonized
standards:**

EN 60335-1:2012+A11:2014+A13:2017+A1:2019+A2:2019+
A14:2019+A15:2021
EN IEC 60335-2-41:2021+A11:2021
EN 62233:2008

Other technical standards and
specifications applied:

Place and date of issue:

Würzburg, 26.01.2024

Signature:

Dipl.-Inform. (Univ.) Korhan Canbolat, Managing Director

If the device is modified without our consent, this declaration of conformity loses its validity.