

# AREBOS

## Kitchen Maschine 1500W

AR-HE-KM1580B/R/S



Please follow all security measures in this user's manual to ensure a secure use.



Thank you for trusting in AREBOS.

Thank you for purchasing our product. Please read the operating instructions carefully before using the product for the first time. If you give the product to a third party, this manual must be handed over with it. Keep the instruction manual for future reference. The drawings in this manual may not match the physical objects. Please refer to the physical objects.

## Security Instructions

### Explanation of the symbols



By means of a CE marking, it can be recognized that a product complies with the legal requirements of European legal standards and therefore may be traded within the European Community.



This product **must not** be disposed of with household waste!



**Warning!** Read the safety instructions carefully. Failure to follow the safety precautions could result in serious injury or damage. Keep the operating instructions in a safe place.



Insulated housing (protection class II)!

### General safety instructions

- Read the operating instructions carefully before putting the appliance into operation and keep the instructions including the warranty, the receipt and, if possible, the box with the internal packing. If you give this device to other people, please also pass on the operating instructions.
- The appliance is designed exclusively for private use and for the envisaged purpose. This appliance is not fit for commercial use. Do not use it outdoors (except if it is designed to be used outdoors). Keep it away from sources of heat, direct sunlight, humidity (never dip it into any liquid) and sharp edges. Do not use the appliance with wet hands. If the appliance is humid or wet, unplug it immediately.
- When cleaning or putting it away, switch off the appliance and always pull out the plug from the socket (pull on the plug, not the cable) if the appliance is not being used and remove the attached accessories.
- Do not operate the machine without supervision. If you should leave the workplace, always switch the machine off or remove the plug from the socket (pull the plug itself, not the lead).

- Check the appliance and the cable for damage on a regular basis. Do not use the appliance if it is damaged. Do not try to repair the appliance on your own. Always contact an authorized technician. To avoid the exposure to danger, always have a faulty cable be replaced only by the manufacturer, by our customer service or by a qualified person and with a cable of the same type.
- Use only original spare parts.
- Pay careful attention to the following “Special Safety Instructions”.

### **Children and Frail individuals**

- In order to ensure your children’s safety, please keep all packaging (plastic bags, boxes, polystyrene etc.) out of their reach.  
**Caution!** Do not allow small children to play with the foil as there is a **danger of suffocation!**
- This appliance shall not be used by children. Keep the appliance and its cord out of reach of children.
- This device is not a toy. Children shall not play with the appliance.
- Appliances can be used by persons with reduced physical, sensory or mental capabilities or lack of experience and knowledge if they have been given supervision or instruction concerning use of the appliance in a safe way and if they understand the hazards involved.

### **Special Safety Instructions for this Machine**

- Always disconnect the appliance from the supply if it is left unattended and before assembling, disassembling or cleaning.
- Switch off the appliance and disconnect from supply before changing accessories or approaching parts that move in use.
- Do not use appliance for other than intended purpose.
- CAUTION: In order to avoid a hazard due to inadvertent resetting of the thermal cut-out, this appliance must
- not be supplied through an external switching device, such as a timer, or connected to a circuit that is regularly switched on and off by the utility.
- Only operate this machine under supervision.
- Do not interfere with any safety switches.
- Do not insert anything into the rotating hooks while the machine is working.
- Place the machine on a smooth, flat and stable working surface.
- Do not insert the mains plug of the machine into the power socket without having installed all the necessary accessories.

## Overview of the Components

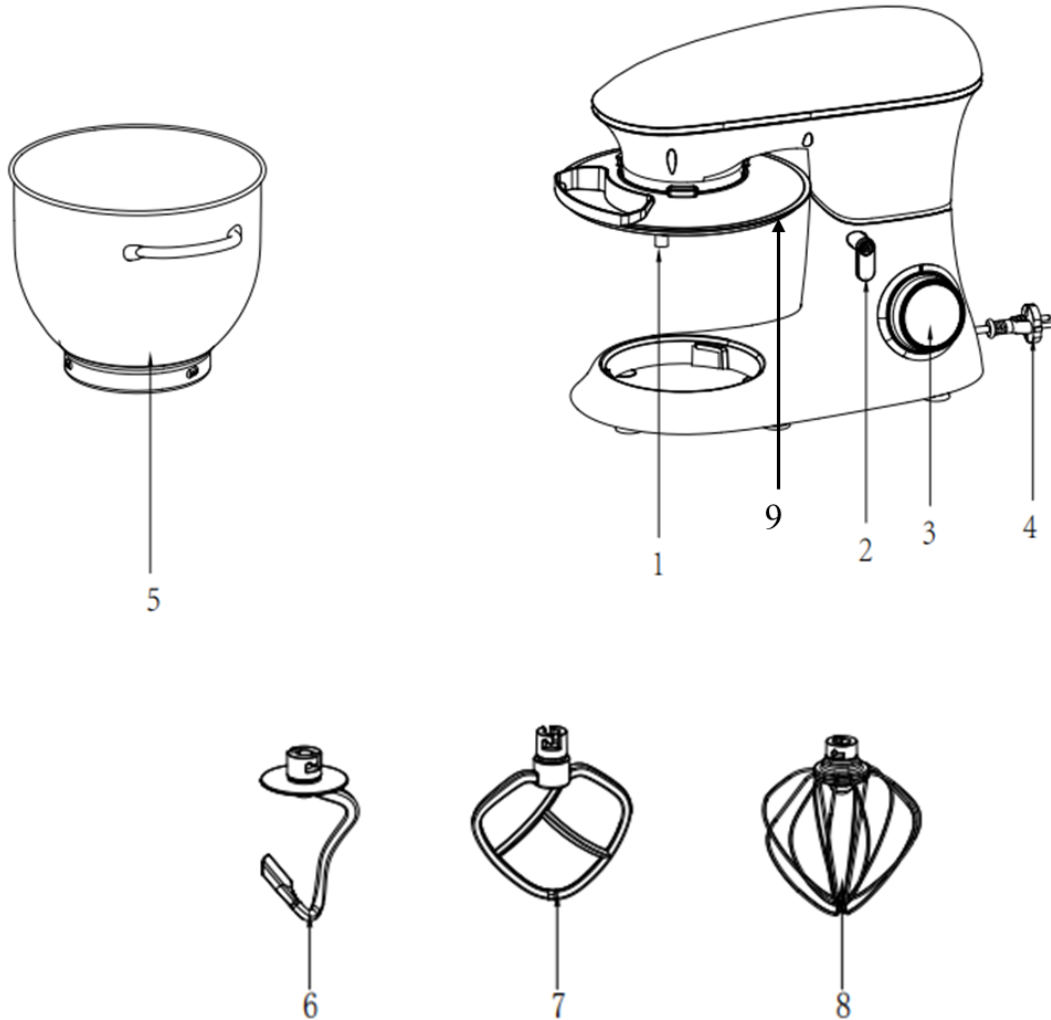

### Main Components and Standard Accessories:

1	Output shaft	6	Dough hook
2	Rise knob	7	Beater
3	Speed knob	8	Whisk
4	Power cord	9	Anti-splash cover
5	Mixing bowl		

## Using the Mixing Bowl

1. In order to lift the arm, clockwise rotation the Rise knob (2). The arm will now move upwards. (Fig 1)
2. Place the pot cover into its body. (Fig 2)
3. Place the mixing bowl into its holding device (Step 1) and turn the bowl clockwise until it locks into place (Step 2). (Fig 3)

4. Mount the required utensil (Dough hook or Beater or Whisk) by inserting the top into the output shaft, and turn anti-clockwise until it locks into place. (Fig 4 & Fig 5)
5. Now fill in your ingredients.

**CAUTION:**

**Do not overfill the mixing bowl!**

- The maximum quantity of ingredients is 2 kg.

6. Lower the arm using the rise knob (2). (Fig 6)
7. Insert the mains plug into a properly installed 220-240 V 50/60 Hz safety power socket.
8. Switch the machine using the speed knob to a speed between 1 and 6 (corresponding to the mixture).
9. For pulse operation (kneading at short intervals), turn the switch to the “PULSE” position. The switch has to be held in this position according to the desired interval length. When the switch is released it returns automatically to the “0” position.
10. After kneading/stirring turn the speed knob (3) back to the “0” position as soon as the mixture has formed a ball. Then remove the mains plug.
11. Push the rise knob (2) downwards and the arm will be raised.
12. The mixture can now be released with the help of a spatula and removed from the mixing bowl.
13. The mixing bowl can now be removed.
14. Clean the parts as described under “Cleaning”.



FIG1

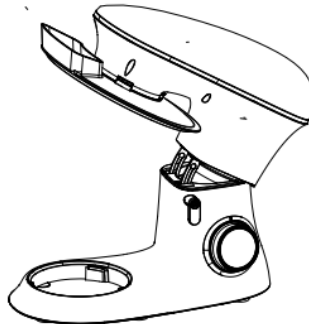

FIG2

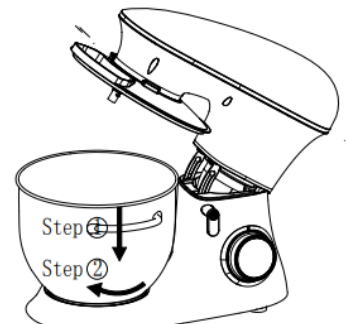

FIG3

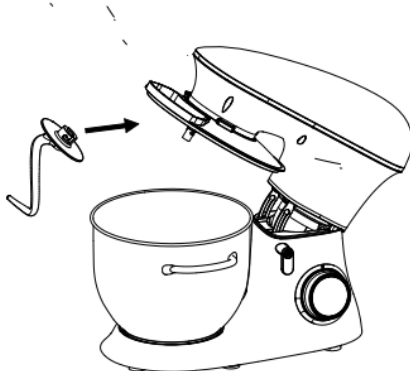

FIG4

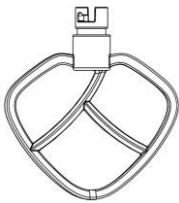
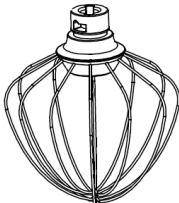

FIG5



FIG6

**Adjusting the levels and using the Dough Hook / whisk / beater for no more than 2 kg of Mixture.**

Use	Picture	Levels	Time (Min)	Maximum	Operation method
Dough hook		1-3	3-5	1000g flour and 538g water	<p>Heavy mixtures (e.g. bread or short pastry)</p> <ul style="list-style-type: none"> <li>To form a cluster, switch to Speed 1 for 30s, followed by speed 2 for 30s, and finally speed 3 run for 2 min to 4 min.</li> </ul>
Beater		2-4	3-10	660g flour and 840g water	<p>Medium-heavy mixtures (e.g. crepes or sponge mixture)</p> <ul style="list-style-type: none"> <li>To use the beater, switch to speed 2 for 20s, then speed 4 run for more than 2min40s.</li> </ul>
Whisk		5-6	3-10	3 egg whites (Minimum)	<p>Light mixtures (e.g. cream, egg white, blanchmange)</p> <ul style="list-style-type: none"> <li>To beat egg white, use Speed 5 or 6 to run 3 min or above until stiff.</li> <li>To whip cream, use Speed 5 or 6 and whip for 3 to 5 mins.</li> </ul>

**CAUTION:**

**Risk of overheating due to excessive operation!**

- **Short operation time:** Do not operate the machine for more than 6 minutes!
- After operating for 6 minutes, please allow a pause of min. 15 minutes before operating again.

## Troubleshooting

NO.	Troubles	Solution
1	The machine doesn't work.	<ul style="list-style-type: none"><li>- Check if the plug is in good contact with the socket.</li><li>- Check if the rise button spring back in place.</li><li>- Check if the machine works continuously more than 10 minutes, and wait until the motor cool down.</li></ul>
2	Noise in the mixing bowl when working (the accessory scraped the bowl).	<ul style="list-style-type: none"><li>- Check if the mixing bowl is properly installed.</li><li>- Check if the accessory installed properly on machine.</li></ul>
3	The pot cover doesn't fit the mixing bowl properly.	<ul style="list-style-type: none"><li>- Check if the pot cover placed on the machine properly.</li><li>- Check if the mixing bowl installed properly on machine and locked correctly.</li></ul>
4	The machine doesn't work on certain speed.	<ul style="list-style-type: none"><li>- Check if the mark on speed knob correspond to the speed silkscreen on housing.</li><li>- Rotate speed knob to 0, and re-check if the machine works.</li></ul>
5	Movements when the machine working.	<ul style="list-style-type: none"><li>- Check if the anti-slip feet fall off.</li><li>- Check if the machine is placed on a smooth and flat tabletop.</li></ul>
6	The rise button didn't spring back in place after installing the mixing bowl and pot cover.	<ul style="list-style-type: none"><li>- Check if the pot cover placed on the machine properly.</li><li>- Check if the mixing bowl is properly installed.</li></ul>

## Technical Specifications

Model	AR-HE-KM1580B/R/S
Nominal Power (Watt)	1500 Watt
Power supply	220-240 V, 50/60 Hz
Protection Class	II
Mixing bowl with handles	8L
Size of machine (L x W x H)	44.8 x 26.9 x 36.7cm
Delivery content	Whisk 1x, Stirrer beater 1x, Kneading hook 1x, anti-splash cover 1x, Mixing bowl 1x, Machine 1x, User Manual 1x
Weight (without packaging)	5.6 kg

## Cleaning

- Before cleaning remove the mains lead from the socket.
- Never immerse the housing with motor in water!
- Do not use any sharp or abrasive detergents.

### Motor Housing

- Only a damp rinsing cloth should be used to clean the outside of the housing.

### Mixing Bowl, Mixing Equipment

- **Caution: The components are not suitable for cleaning in a dishwasher. If exposed to heat or caustic cleaners they might become misshapen or discolored.**
- Components that have come into contact with food can be cleaned in soapy water.
- Allow the parts to dry thoroughly before reassembling the device.
- Please apply a small quantity of vegetable oil likely to the screens after they have dried.



## Environmentally friendly disposal

**Warning Danger of suffocation!** Packaging material is dangerous for children. Never let children play with packaging material.

### Disposal and packaging

- The packaging of your unit consists of materials that are necessary to guarantee effective protection during transport. These materials are fully recyclable and therefore reduce the environmental impact. Dispose of the packaging in a bin for recyclable materials.

### Disposal of waste equipment

- Old appliances must be disposed of in accordance with the guidelines and regulations of the local waste disposal authority. Check with your local administration for the address of the nearest recycling centre and deliver your appliance there.



The symbol of the crossed-out dustbin on a Waste electrical or electronic equipment indicates that it must not be disposed of with household waste at the end of its life. Collection points for waste electrical and electronic equipment are available free of charge in your area. You can obtain the addresses from your city or local government. You can find out about other return options created by us on our website [www.arebos.de](http://www.arebos.de).

The separate collection of Waste electrical or electronic equipment is intended to enable the reuse, recycling or other forms of recovery of Waste electrical or electronic equipment and to avoid the negative consequences of disposal on the environment and human health.

**Our customer service number: Tel. +44 (0) 208 068 5604**

**Fax: +49 (0) 931 4523 2799 / E-Mail: [info@arebos.de](mailto:info@arebos.de)**

Office address: Canbolat Vertriebs GmbH • Gneisenaustraße 10-11 • 97074 Würzburg

**Return address** can be found in the imprint: <https://www.arebos.de/impressum/>

## Revocation/Return

- Check the product for transport damage. Immediately report any damage to the transport company that delivered the product.
- **Revocation/Return:** Please note that the full purchase price can only be refunded if the returned goods are unused, new and in their original packaging.

## Declaration of Conformity EU

We, the

Canbolat Vertriebs GmbH, Gneisenaustraße 10--11, 97074 Würzburg, Germany,

hereby declare that the equipment described below, by virtue of its design and construction and in the versions placed on the market by us, complies with the relevant essential health and safety requirements of the EU directives.

Name of the product: AREBOS Kitchen Maschine 1500W

Model number: AR-HE-KM1580B; AR-HE-KM1580R; AR-HE-KM1580S

Article number: 4260627427864 (black); 4260627427871 (red); 4260627427888 (silver)

Should the appliance be modified without our consent, this declaration of conformity will lose its validity.

Verified acc. to:

Standard/Directives EU:

EN 55014-1:2017

EN 55014-2:2015

EN IEC 61000-3-2:2019

EN 61000-3-3:2013+A1:2019

EMC Directive 2014/30/EU

EN 60335-1: 2012+A11:2014+A13:2017+A1:2019+A14:2019+A2:2019

EN 60335-2-14:2006 + A1:2008 + A11:2012 + AC:2013 + A12:2016

EN 62233:2008

Low Voltage Directive 2014/35/EU

RoHS Directive 2011/65/EU

ErP Directive 2009/125/EC

Date/Manufacturer Signature/Location:

Würzburg, 21.02.2022



Signature:

Dipl.-Inform. (Univ.) Korhan Canbolat, Managing Director

Representative of these instructions for use/technical data:

Dipl.-Inform. (Univ.) Korhan Canbolat, Managing Director

Office address:

Canbolat Vertriebs GmbH

Gneisenaustraße 10-11

D-97074 Würzburg

Return address can be found in the imprint: <https://www.arebos.de/impressum/>

VAT identification number: DE 263752326

Court of the Commercial Register is Würzburg, HRB 10082

WEEE Reg.-No. DE 61617071