

AREBOS

Ashes Vacuum Cleaner - Premium

AR-HE-AS605

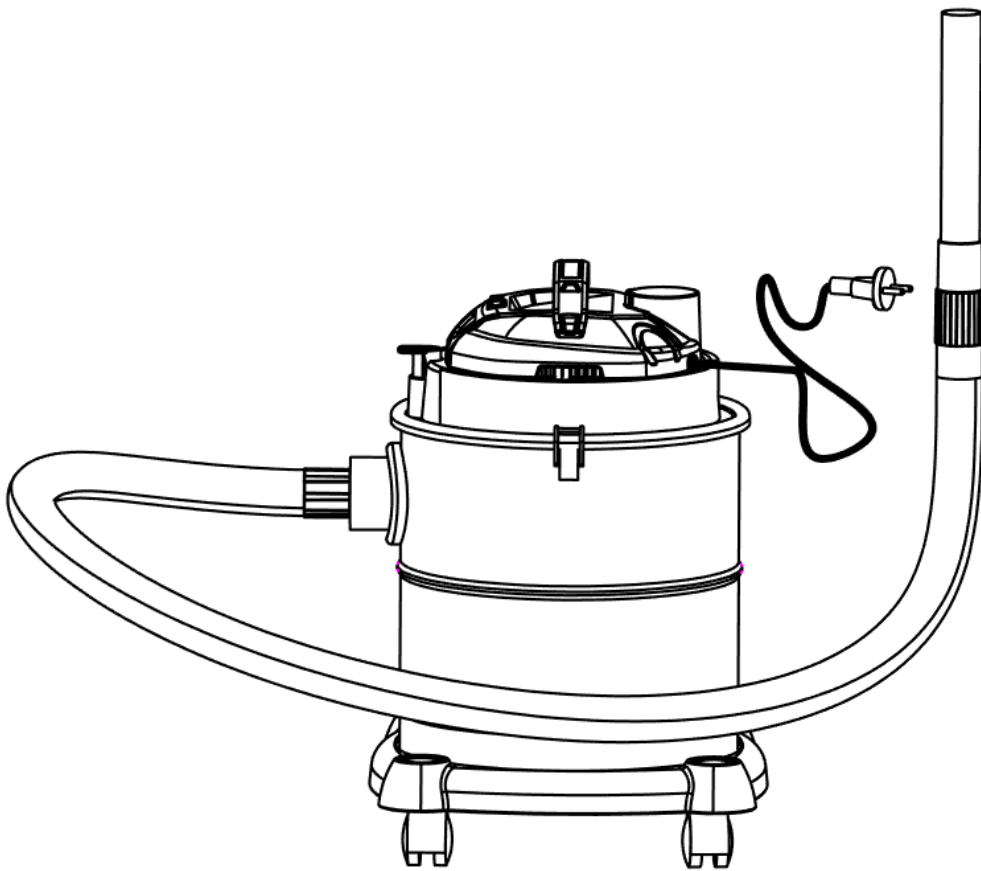

Please follow all security measures in this user's manual to ensure a secure use.



Thank you for trusting in AREBOS.

Table of Contents

1. Safety Instructions.....	3
1.1 Explanation of the symbols.....	3
1.2 Safety Warnings	4
2. Appliance Figure.....	4
3. Area of application	5
4. Restriction of Use	5
5. Operation.....	5
6. Cleaning and maintenance	6
7. Technical Data	7
8. Error detection	7
9. Environmentally friendly disposal.....	8
9.1 Disposal and packaging.....	8
9.2 Disposal of old equipment	8
EU Declaration of Conformity.....	9

Thank you for purchasing our product. Please read the operating instructions carefully before using the product for the first time. If you give the product to a third party, this manual must be handed over with it. Keep the instruction manual for future reference.

The drawings in this manual may not match the physical objects. Please refer to the physical objects.

1. Safety Instructions

1.1 Explanation of the symbols



This product **must not** be disposed of with household waste!



By means of a CE marking, it can be recognized that a product complies with the legal requirements of European legal standards and therefore may be traded within the European Community.



Protective insulated housing (protection class II)!

RoHS

Restriction of the use of certain hazardous substances in the area of heavy metals, brominated flame retardants and plasticisers to protect human health and the environment



This product has been tested and certified Intertek. The symbol "GS" stands for tested safety. Products marked with this symbol comply with the requirements of the German Product Safety Act (ProdSG).



Warning of electrical voltage!



Warning! Read the safety instructions carefully. Failure to follow the safety precautions could result in serious injury or damage. Keep the operating instructions in a safe place.

1.2 Safety Warnings

If the supply cord is damaged, it must be replaced by the manufacturer, its service agent or a similarly qualified person in order to avoid a hazard.

This appliance is not intended for use by persons (including children) with reduced physical, sensory or mental capabilities or lack of experience and knowledge, unless they have been given supervision or instruction concerning use of the appliance by a person responsible for their safety. Children should be supervised to ensure that they do not play with the appliance.

Substance to be vacuumed - cold ashes from fireplaces, wood/coal stoves, ashtrays, grill.

In the manual the following analogous information has to be given:

“Cold Ash” is ash cooled down for a sufficient time without any pockets of embers inside. This can be confirmed by scouring the ash for pockets of embers by using metal tools before using the ash vacuum cleaner. Cold ash does not emit any recognizable heat.

Empty and clean vacuum cleaner before and after vacuuming to avoid the collection of materials that could pose a fire hazard in the vacuum cleaner.

Do not vacuum any soot or flammable substances.

Always check hoses and vacuum cleaner for heating when vacuuming.

Always empty and clean vacuum cleaner before and after vacuuming.

2. Appliance Figure

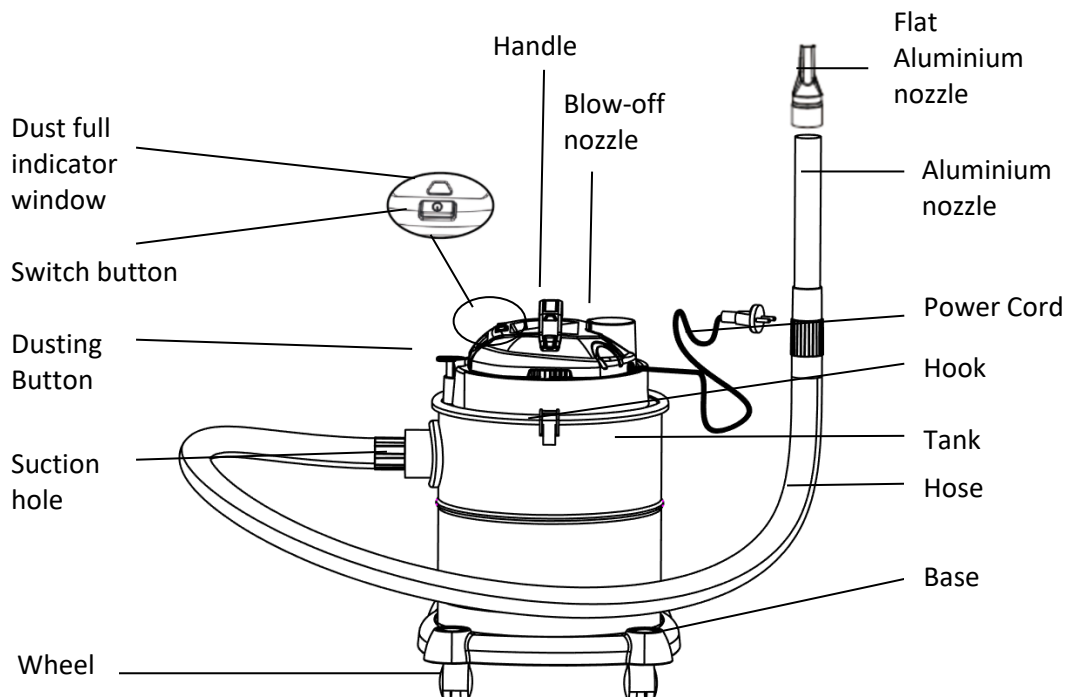

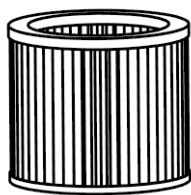

Filter



Hose



Wheels

Tube

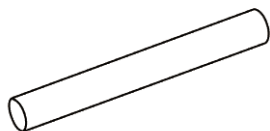

Nozzle

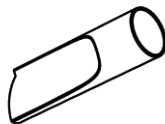

3. Area of application





Substance to be vacuumed - cold ashes from fireplaces, wood/coal stoves, ashtrays, grill
 Empty and clean vacuum cleaner before and after vacuuming to avoid the collection of materials that could pose a fire hazard in the vacuum cleaner.

4. Restriction of Use

- Do not use for the separation of health-hazardous dusts (dust classes L, M, H).
- Do not vacuum soot.
- Vacuum only ashes from admissible fuels.
- Do not vacuum any hot, burning or glowing objects.
- Do not vacuum any objects that are hotter than > 40 °C.
- Do not vacuum any flammable substances.

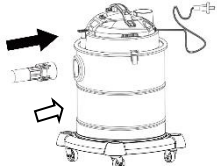
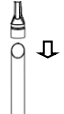
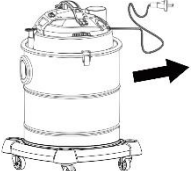
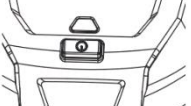

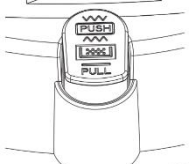
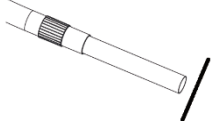
5. Operation

	<p>Before you start the appliance, make sure that the dust filter is in the position. Ensure that the butterfly nut is tightened.</p>
	<p>Assemble the ash vacuum cleaner.</p>

	<p>Assemble the hose.</p>
	<p>Assemble the flat aluminium nozzle.</p>
	<p>Unwind the power cord.</p>
	<p>Plug the appliance and switch on (Press the switch button).</p>
	<p>When the dust full indicator window shows red, please clean or replace filter.</p>
	<p>If the suction power decreases you can improve pressing the dusting button.</p>
	<p>Keep the aluminium nozzle end covered when making self-cleaning.</p>
	<p>Unplug the appliance after use.</p>

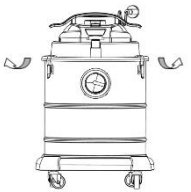
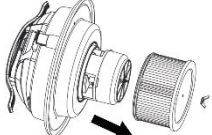
6. Cleaning and maintenance

	<p>Open the dust container.</p>
	<p>Back-out the butterfly nut and take out the filter.</p>

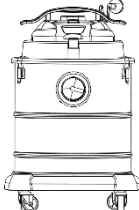
	Empty the dust container.
	Clean the filter by shaking off the ash.
	Assemble the ash vacuum cleaner.

7. Technical Data

- max. power: 1200W
- Volume: 20L
- Weight: 4,8kg
- Noise level: 78 dB(A)
- Suction power: > 16kPa
- Power supply: 220-240V AC; 50/60Hz

8. Error detection

Before you contact our service center, please check the following:

Problem	Possible reason	Advice
Motor does not start	<ul style="list-style-type: none"> - Power cord not firmly plugged into outlet. - Outlet damaged. - Cleaner not switched on. - Start motor temperature protection. 	<ul style="list-style-type: none"> - Plug unit firmly. - Check the Outlet. - Switch on the appliance - Wait about 30 minutes to start the machine again.
Suction power is weaker	<ul style="list-style-type: none"> - Unit clogged. - Dust filter needs cleaning. - Dust container not in position. 	<ul style="list-style-type: none"> - Remove the blockage. - Clean the dust filter. - Attach the dust container again to the cleaner.

9. Environmentally friendly disposal

Warning Danger of suffocation! Packaging material is dangerous for children. Never let children play with packaging material.

9.1 Disposal and packaging

- The packaging of your unit consists of materials that are necessary to guarantee effective protection during transport. These materials are fully recyclable and therefore reduce the environmental impact. Dispose of the packaging in a bin for recyclable materials.

9.2 Disposal of old equipment

- Old appliances must be disposed of in accordance with the guidelines and regulations of the local waste disposal authority. Check with your local administration for the address of the nearest recycling centre and deliver your appliance there.



The symbol of the crossed-out dustbin on a Waste electrical or electronic equipment indicates that it must not be disposed of with household waste at the end of its life. Collection points for waste electrical and electronic equipment are available free of charge in your area. You can obtain the addresses from your city or local government. You can find out about other return options created by us on our website www.arebos.de.



The separate collection of Waste electrical or electronic equipment is intended to enable the reuse, recycling or other forms of recovery of Waste electrical or electronic equipment and to avoid the negative consequences of disposal on the environment and human health.

Our customer service number: Tel. +44 (0) 208 068 5604

Fax: +49 (0) 931 4523 2799 / E-Mail: info@arebos.de

Office address: Canbolat Vertriebs GmbH • Gneisenaustraße 10-11 • 97074 Würzburg

Return address can be found in the imprint: <https://www.arebos.de/impressum/>

EU Declaration of Conformity

We, the

Canbolat Vertriebs GmbH, Gneisenaustraße 10-11, 97074 Würzburg, Germany,

hereby declare that the equipment described below, by virtue of its design and construction and in the versions placed on the market by us, complies with the relevant essential health and safety requirements of the EU directives.

Product name: AREBOS Ashes Vacuum Cleaner - Premium

Model number: AR-HE-AS605

Article number: 4260627424962

Should the appliance be modified without our consent, this declaration of conformity will lose its validity.

Relevant european Directives:

2014/35/EU (Low Voltage Directive)

2014/30/EU (Electromagnetic Compatibility Directive)

2011/65/EU (EU) 2015/863 (RoHS Directive)

Applied harmonised Standards:

EN 60335-2-2 :2010+A11:2012+A1:2013

EN 60335-1:2012+AC:2014+A11:2014+A13:2017+A1:2019+A2:2019+A14:2019

EN 62233:2008

EN 55014-1:2017+A11:2020

EN 55014-2:2015

EN 61000-3-2:2019

EN 61000-3-3:2013+A1:2019

Other standards and specifications:

AfPS GS 2019:01 PAK

Date/Signature Manufacturer/Place:

Würzburg, June 15, 2022



Signature:

Dipl.-Inform. (Univ.) Korhan Canbolat, Managing Director

Representative of these instructions for use/technical data:

Dipl.-Inform. (Univ.) Korhan Canbolat, Managing Director

Office address:

Canbolat Vertriebs GmbH

Gneisenaustraße 10-11

D-97074 Würzburg

Return address can be found in the imprint: <https://www.arebos.de/impressum/>

VAT identification number: DE 263752326

Court of the Commercial Register is Würzburg, HRB 10082

WEEE Reg.-No. DE 61617071