

AREBOS

Tomato greenhouse

AR-HE-TFG1



Please follow all safety measures in this user manual to ensure safe use.

Thank you for your trust in AREBOS.

Table of contents

1 Safety	3
1.1 Explanation of the symbols	3
1.2 Intended use	3
1.3 General safety instructions	3
2 Scope of delivery and technical data ...	4
2.1 Scope of Delivery	4
2.2 Technical Data	5
3 Assembly	5
4 Maintenance and care.....	5
4.1 Cleaning	5
5 Environmentally friendly disposal	6
5.1 Disposal and packaging	6
Imprint.....	6

Thank you for choosing our product. Please read the user manual carefully before using the product for the first time. If you give the product to a third party, this instruction must be passed with them. Keep the instruction manual for future reference. The drawings in this manual may not match the physical objects.

1 Safety

1.1 Explanation of the symbols



Warning! Read the safety instructions carefully. Failure to follow safety precautions may result in serious injury or damage. Keep the instruction manual in a safe place.



Note: For safety reasons, wear work gloves during assembly!



Be careful when using this product.

1.2 Intended use

- This product is a greenhouse for private outdoor use, for example in gardens and courtyards. Any other use or modification of the product is considered to be not intended and poses a significant risk of accidents. The manufacturer assumes no liability for damage caused by use contrary to its intended purpose. Not intended for commercial use.













1.3 General safety instructions

- Please keep all safety guidelines and instructions for future reference. Make sure that all documents are passed on to the person to whom you are handing over the product.
- Warning! Risk of injury or choking in young children
- Keep packaging materials out of the reach of children as there is a risk of choking. Make sure that both the packaging and the product are kept safely away from children.
- Caution! This product is not a climbing frame or toy
- Do not allow children or other persons to climb or play with the product, as it could tip over and cause injury.
- Do not sit or stand on the product.
- Use the product only as intended to avoid accidents or damage.
- Wear gloves and goggles during assembly to protect yourself from sharp edges.
- For safe handling, it is recommended that two people help with the assembly and moving of the product.
- Make sure the assembly area is free of children and pets to prevent accidents.
- Check all parts for damage or defects before starting assembly. Do not use damaged parts.

- Mount the product on a flat, stable surface to ensure proper alignment and balance.
- The integrity of all joints and the hold of the ground spikes should be checked regularly.
- Protect the product from strong wind and storm. Place the product in a place protected from the wind.
- When installing and using this product, in addition to these safety instructions, comply with all municipal building and other regulations. Check with your authority about current regulations in force.

2 Scope of delivery and technical data

2.1 Scope of Delivery

Part	Image	Quantity
1		3
2		1
3		4
4		2
5		4
6		4
7		2
8		2
9		4
10		7
11	 Cover	1
D		8

2.2 Technical Data

EAN	4252023125949
Model	AR-HE-TFG1
Overall Dimensions	150*100*50cm
Dimensions opening	142*82cm
Material Frame	Metal
Material	Polyethylene film (130g/m ² PE fabric)
Weight	2.3kg

3 Assembly

- To assemble it, follow the steps shown in Figures 1-4.
- Disassemble the product in reverse order.

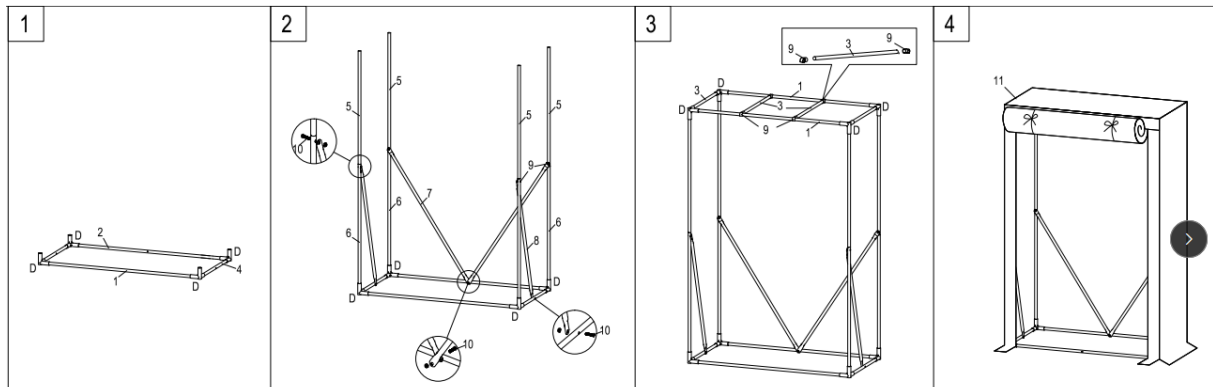

4 Maintenance and care

4.1 Cleaning

- Allow all parts to dry thoroughly before storing the product. This prevents mould, odours or discolouration.
- Clean the product with a damp, lint-free cloth.
- Maintain the zipper with a silicone spray.

5 Environmentally friendly disposal

Warning: Choking hazard! Packaging material is dangerous for children. Never let children play with packaging materials.

5.1 Disposal and packaging

- The packaging of the item is made of materials necessary to ensure effective protection during transport. These materials are fully recyclable and thus reduce the environmental impact. Dispose of the packaging in a bin for recyclable materials.

Our customer service number: Tel. [Phone: +49 931 90 80 3000](tel:+4993190803000)

E-mail: info@arebos.de

Office address: Canbolat Vertriebs GmbH • Gneisenaustraße 10-11 • 97074 Würzburg

Imprint

Product Name: Tomato Greenhouse

Model Number: AR-HE-TFG1

Item number: 4252023125949

If the product has a modification that has not been approved by us, this statement will lose its validity.

Date/Manufacturer's signature/Location:

Würzburg 02 Oktober 2024



Signer identification:

Korhan Canbolat, Head of the Company

Technical Documentation Representative:

Korhan Canbolat

Office Address:

Canbolat Vertriebs GmbH

Gneisenaustraße 10-11

D-97074 Würzburg

The return address can be found in the imprint: <https://www.arebos.de/impressum/>

Sales tax identification number: DE 263752326 Commercial register court is Würzburg, HRB 10082WEEE Reg.-Nr. DE 61617071